

# Htek IP Phones UC921(G) User Manual

**Version 2.0.4.6.16**  
**July. 2019**

## Notices Information

### Copyright

Copyright © 2005 - 2019 Nanjing Hanlong Technology CO., LTD. All rights reserved.

Nanjing Hanlong Technology Co., LTD. owns all the rights to modify and copy this document at any time. And all the illustrations and text in this document are copyright protected. Therefore, no parts of this document may be used or reproduced, transmitted by the third parties for any purposes without the express written permission of Nanjing Hanlong Technology CO., LTD.

When this document is made available on [www.htek.com](http://www.htek.com), Nanjing Hanlong Technology Co., LTD. gives its right to download and print copies of this content only for private use as a user manual. No parts shall have the right to alter, modify or use as commercial means without prior written permission from Nanjing Hanlong Technology Co., LTD.

### Safety Instructions

- To use the Phone, please follow the instructions in this user manual.
- Use the power adapter supplied with your phone. Other power adapters may damage the phone.
- This phone is only for indoor use. And also avoid in high humidity, water and some other liquids.
- Do not use the phone during thunderstorms.
- CE
- FCC

### WEEE Warning



To avoid the potential effects on the environment and human health as a result of the presence of hazardous substances in electrical and electronic equipment, end users of electrical and electronic equipment should understand the meaning of the crossed-out wheeled bin symbol. Do not dispose of WEEE as unsorted municipal waste and have to collect such WEEE separately.

### Cleaning

To clean the device, use an anti-static cloth. Please avoid cleaning liquids as they might



damage the surface or internal electronics of the phone.

## FCC Statement

This device complies with Part 15 of the FCC Rules. Operation is subject to the following two conditions: (1) This device may not cause harmful interference, and (2) this device must accept any interference received, including interference that may cause undesired operation.

**WARNING:** Any changes or modifications not expressly approved by the party responsible for compliance could void the user's authority to operate this equipment.

**NOTE:** This equipment has been tested and found to comply with the limits for a Class B digital device, pursuant to Part 15 of the FCC Rules. These limits are designed to provide reasonable protection against harmful interference in a residential installation.

This equipment generates uses and can radiate radio frequency energy and, if not installed and used in accordance with the instructions, may cause harmful interference to radio communications.

However, there is no guarantee that interference will not occur in a particular installation. If this equipment does cause harmful interference to radio or television reception, which can be determined by turning the equipment off and on, the user is encouraged to try to correct the interference by one or more of the following measures:

- Reorient or relocate the receiving antenna.
- Increase the separation between the equipment and receiver.
- Connect the equipment into an outlet on a circuit different from that to which the receiver is connected.
- Consult the dealer or an experienced radio/TV technician for help.

\*RF warning for Mobile device:

This equipment complies with FCC radiation exposure limits set forth for an uncontrolled environment. This equipment should be installed and operated with minimum distance 20cm between the radiator & your body.

# Table of Content

Notices Information-----	2
Copyright-----	2
Safety Instructions-----	2
WEEE Warning-----	2
Cleaning-----	2
FCC Statement-----	3
Table of Content-----	4
Getting Started-----	8
Packing List-----	8
Phone Installation-----	10
1. Attach the phone stand-----	10
2. Connect the Handset and optional Headset-----	10
3. Connect the Network and Power-----	10
Initialization Process-----	11
Status-----	12
Registration-----	16
Idle Screen-----	20
Getting Familiar with Your Phone-----	22
Hardware Components Preview-----	22
Icon Preview-----	25
LED Instruction-----	28
Power Indicator LED-----	28
Line LED (Line Key set as Line)-----	28
BLF or BLF List Key LED ( Line/Line Key set as BLF)-----	28
Shared Line LED-----	29
Other Key Led-----	29
User Interface-----	30
Line Key Function Overview-----	31
Basic Setting Configuration-----	33
General Settings-----	33
Web Login-----	33
Administrator Password-----	35
Display Mode-----	36
Language-----	36
Wallpaper-----	37
Screen Saver-----	39
Backlight-----	42
Time and Date-----	42
LED Status Setting-----	46
Key as Send-----	47
Network Setting-----	48

IPv4	48
IPv6	51
IPv4&IPv6	53
PC Port	54
Contact Setting	55
Local Directory	56
Remote Phonebook	63
LDAP Phonebook	63
Search Contact	66
Call History Setting	68
Call History	68
Audio Setting	71
Ring Tone	71
Volume	73
Voice Mail Tone	74
Play Hold Tone	74
Play Hold Tone Delay	75
System Settings	75
Dial Plan	75
Dial-Now Timeout	76
No Key Entry Timeout	77
Emergency Call	77
Lable Scroll	78
Show Missed Calls	78
Auto Logout Time	78
Reboot in Talking	79
Detect IP Conflict	79
Redial Mode	79
Keypad Lock	79
Suppress DTMF Display	80
Suppress DTMF Display Delay	80
Check-Syn With Authenticate	81
Other features settings	81
Action URL	81
Softkey Layout	83
Programmable Key	84
Basic Call Features	86
Place a Call	86
End a Call	87
Redial a Call	87
Receive a Call	87
Incoming Call Show Mode	88
Auto Answer	88
Call Hold	89

Call Transfer-----	89
Call Conference-----	92
Call Forward-----	93
Call Return-----	98
Call Back-----	99
Call Waiting Tone-----	99
Hide Caller ID-----	100
Reject Anonymous-----	101
Call Mute-----	102
DND-----	102
Hot Line-----	103
Auto Redial-----	104
Function Key Features and Settings-----	104
Line-----	105
Shared Line-----	106
Speed Dial-----	107
BLF-----	108
BLF List-----	110
Voice Mail-----	111
Direct Pickup-----	113
Group Pickup-----	114
Call Park-----	114
Intercom-----	115
Intercom Barge-----	116
DTMF-----	116
Prefix-----	117
Local Group-----	118
XML Group-----	118
XML Browser-----	119
LDAP-----	120
Network Directories-----	120
Conference-----	121
Forward-----	122
Transfer-----	122
Hold-----	123
DND-----	124
Redial-----	124
SMS-----	125
Send SMS-----	125
Set SMS Line Key-----	126
Record-----	127
URL Record-----	128
Paging-----	128
Group Listening-----	129

Public Hold-----	129
Private Hold-----	130
Hot Desking-----	130
ACD-----	131
Zero Touch-----	132
Multicast Paging-----	133
Sending RTP Stream-----	133
Receiving RTP Stream-----	134
Upgrade-----	136
Factory Reset-----	136
Pcap Feature-----	137
System Log-----	138
Upgrade-----	138
Configuration File-----	140
Troubleshooting-----	142
Why is the phone LCD screen blank?-----	142
Why does the phone display “Network Unavailable”?-----	142
Why can’t I get a dial tone?-----	142
Where to set the tone?-----	142
How to download XML Configuration?-----	143
How to Import Trusted CA certificate?-----	143
How to Import Server CA certificate?-----	144
How to use Vlan?-----	145
How to use LLDP?-----	145
How to Set LCD and Web GUI?-----	145
How to Upgrade via FTP?-----	145
How to make Ringtone?-----	146
How to use Open VPN?-----	146
Provisioning Guide on Free PBX-----	146
Redundancy Server-----	146
How to Use Auto Provision Phonebook?-----	146
All Documents-----	146

## Getting Started

### Packing List

The package contains the following parts, please check if all the items are not missed:

1. The phone station

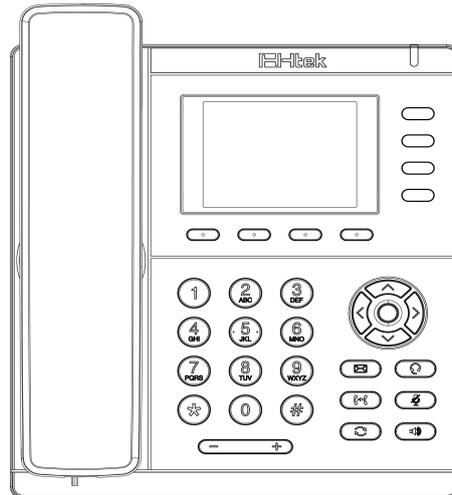

2. The phone stand

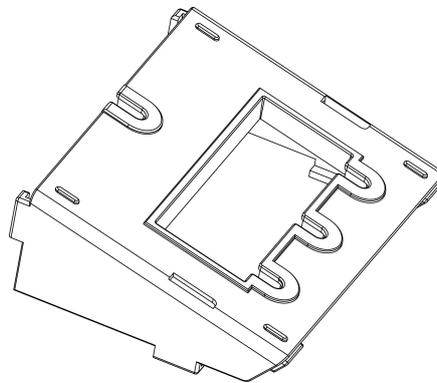

3. Handset

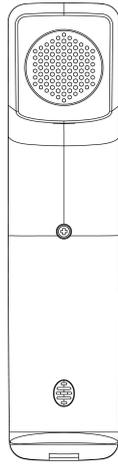

4. Headset cord

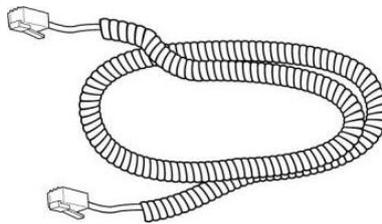

5. Power adapter

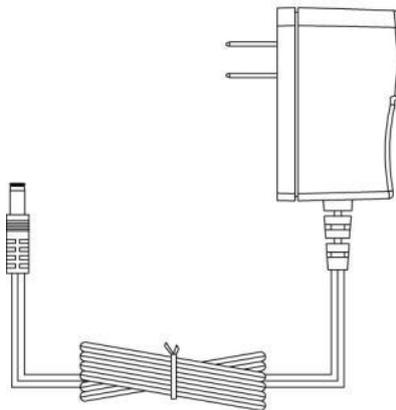

6. Ethernet cable

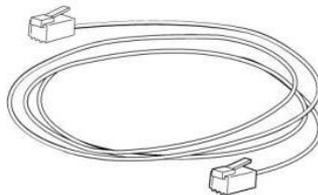

7. Quick installation reference



## Phone Installation

### 1. Attach the phone stand

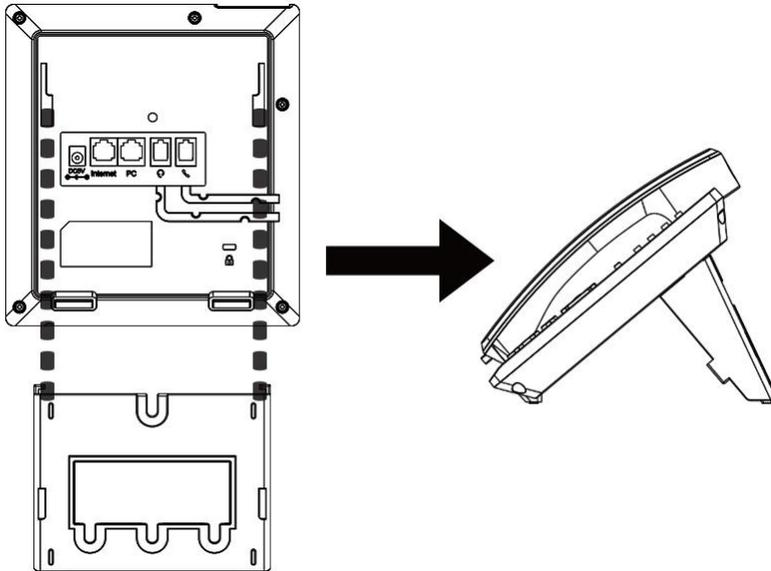

### 2. Connect the Handset and optional Headset

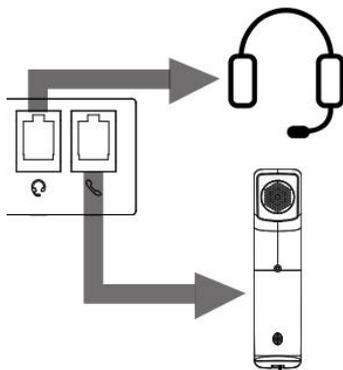

### 3. Connect the Network and Power

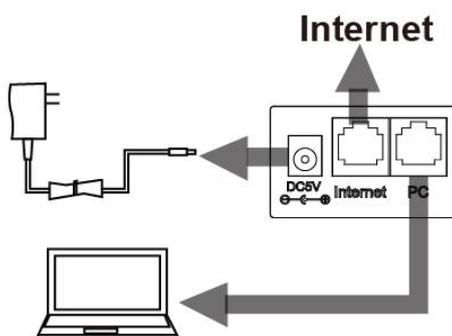

## Initialization Process

After your phone has been powered up, the system boots up and performs the following steps:

Automatic Phone Initialization

The phone finishes the initialization process by loading the saved configuration. The phone LCD screen will display “Booting”

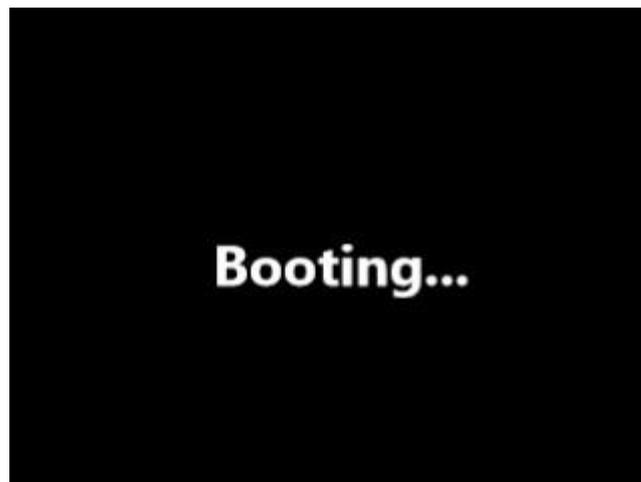

And then show “Initializing” during the initialization.



The IP Phone will upgrade the firmware if there is a new firmware on your server. And the IP Phone will show “Check firmware, please wait...” after initialization.

Then IP Phone will show Reboot information:



By default, the phone attempts to contact a DHCP server in your network in order to obtain its valid network settings, e.g. IP address, subnet mask, default gateway, DNS server.

## Status

You can view the system status of your phone via phone user interface or web user interface. The information of phone status includes: Information (e.g., Model, IPV4, IPV6, MAC, Firmware, Hardware), Network (e.g., WAN Type, IP, Mask, LAN Type, Gateway, DNS ...), Accounts (e.g., register status of accounts)

### To view the phone status via Phone interface:

1. Press Menu → Status → Information

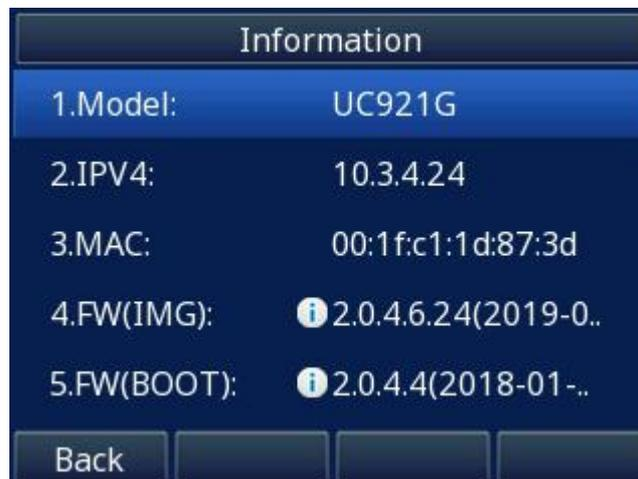

2. Press Menu → Status → Network

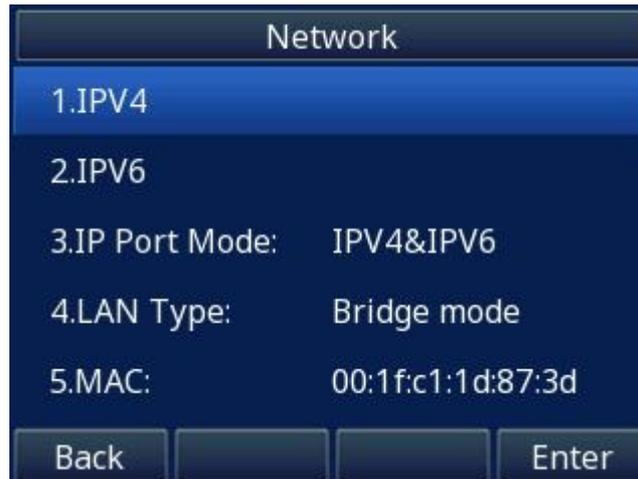

3. Press Menu→ Status→ Network→ IPV4

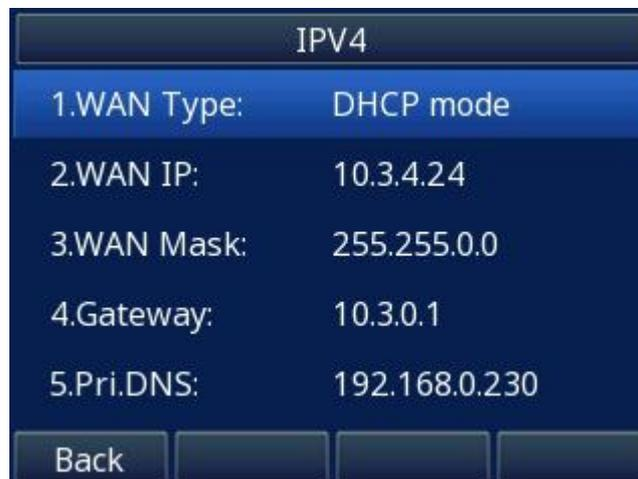

4. Press Menu→ Status→ Network→ IPV6

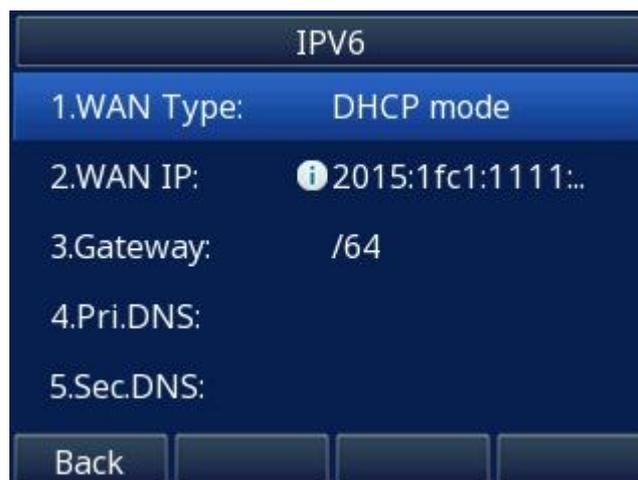

5. Press Menu→ Status→ Accounts (UC921(G) support four accounts)

Accounts	
1.Empty:	Not Registered
2.Empty:	Not Registered
3.Empty:	Not Registered
4.Empty:	Not Registered
5.Empty:	Not Registered
Back	

**To view the phone status via Web interface:**

Login webpage (For How to login, please refer to [Web Login](#))

View the information of Version, Account Status and Network.

### ● Version [?](#)

Product Model	UC921G
Firmware Version	BOOT-2.0.4.4(2018-01-20 13:34:00) IMG-2.0.4.6.24(2019-07-02 17:28:00) ROM-2.0.4.6.24(2019-07-02 17:28:00) DSP-9.0.3(Patch 1.0.16)

### ● Account Status [?](#)

Account1	Disabled
Account2	Disabled
Account3	Disabled
Account4	Disabled
Account5	Disabled
Account6	Disabled
Account7	Disabled
Account8	Disabled

### ● Network [?](#)

IP Mode (IPv4/IPv6)	IPv4
Device Type	Bridge
MAC Address	00:1f:c1:1d:87:3d
Current Time	05-07 04:21:33

### ● IPv4 Setting

WAN Port Type	DHCP
WAN IP Address	10.3.4.24
Subnet Mask	255.255.0.0
Gateway	10.3.0.1
Primary DNS	192.168.0.230
Secondary DNS	

● **Memory Free** 26500 KB

● **System Up Time** 0 day(s) 0 hour(s) 13 min(s) 12 sec(s)

● **Restart**

Restart

## Registration

### To register via Phone interface

1. Press Menu→ Settings→ Advanced Setting (default password: admin)→ Accounts
2. Select the desired account
3. Select Enable for Active
4. Select the desired Profile of the account.
5. Fill the SIP User ID, Authenticate ID
6. Fill the Password and Name (shown on LCD).
7. Press Save to save the configuration.



### Note:

If there is a port of sip server, you need to press “1” on the keypad, then you will find the “.”.

### Additional Information

When the current input method is ABC/abc/2ab,

Pressing “1”, you will find “, . ? ;”

Pressing “0”, you will find “ < > ( ) { } [ ] \_ - ”

Pressing “\*”, you will find “ \* / ! @ \$ ”

Pressing “#”, you will find “ # % & \* | ”

### To register via Web interface

1. Login webpage and Click Profile→ Basic
2. Select the desired profile from the pull-down list of Profile in the Profile field.

Profile		Profile 1
* Primary SIP Server	<input type="text" value="10.13.0.12"/>	<a href="#">?</a>
Failover SIP Server	<input type="text"/>	<a href="#">?</a>
Second Failover SipServer	<input type="text"/>	<a href="#">?</a>
Prefer Primary SIP Server	<input checked="" type="radio"/> No <input type="radio"/> Yes	<a href="#">?</a>
Current SIP Server	10.13.0.12	
DHCP SIP Server	<input checked="" type="radio"/> No <input type="radio"/> Yes	
Outbound Proxy	<input type="text"/>	<a href="#">?</a>
Backup Outbound Proxy	<input type="text"/>	<a href="#">?</a>
* SIP Transport	<input checked="" type="radio"/> UDP <input type="radio"/> TCP <input type="radio"/> TLS	<a href="#">?</a>
NAT Traversal	<input type="radio"/> No <input checked="" type="radio"/> No, but send keep alive <input type="radio"/> STUN	
DNS Mode	<input checked="" type="radio"/> A Record <input type="radio"/> SRV <input type="radio"/> NAPTR/SRV	
Call Message Format	<input type="text" value="Regular"/>	
Transfer Release Trigger:	<input type="text" value="NOTIFY with 200OK"/>	
SIP Registration	<input type="radio"/> No <input checked="" type="radio"/> Yes	
Unregister On Reboot	<input checked="" type="radio"/> No <input type="radio"/> Yes	
Register Expiration	<input type="text" value="15"/>	<a href="#">?</a>
Outgoing Call Without Registration	<input type="radio"/> No <input checked="" type="radio"/> Yes	
RPort	<input checked="" type="radio"/> No <input type="radio"/> Yes	
RFC 2543 Hold	<input type="radio"/> No <input checked="" type="radio"/> Yes	

3. Fill the Primary SIP Server and other profile information.
4. Select the SIP Transport.
5. Click  to save the configuration.
6. Click Account→ Basic.
7. Select the desired account from the pull-down list of Account in the Account field.

<b>Account</b>	Account 1 ▾
Account Status	012@10.13.0.12:5060 : Registered; UDP
* Account Active	<input type="radio"/> No <input checked="" type="radio"/> Yes
Profile	Profile 1 ▾
Label	<input type="text"/> ?
* SIP User ID	012 ?
* Authenticate ID	012 ?
* Authenticate Password	..... ?
Name	<input type="text"/> ?
Local SIP Port	5060 ?
Use Random Port	<input checked="" type="radio"/> No <input type="radio"/> Yes
Voice Mail UserID	<input type="text"/> ?
Dial Plan	<input type="text"/>
Eventlist BLF URL	<input type="text"/>
Shared Line	Disable ▾
SCA Barge-In	Disable ▾ ?
Direct Call Pickup Code	<input type="text"/>
Group Call Pickup Code	<input type="text"/>
Feature Key Sync	Disable ▾
<input type="button" value="SaveSet"/> <input type="button" value="Restart"/>	

8. Select Yes for Account Active.

9. Select the desired Profile.

10. Fill the SIP User ID, Authenticate ID, Authenticate Password and other account information.

11. Click  to save the configuration.

#### To register via DHCP SIP Server

1. Login web page and Click Profile→ Basic

2. Select the desired profile from the pull-down list of Profile in the Profile field.

<b>Profile</b>	Profile 1
* Primary SIP Server	10.13.0.12
Failover SIP Server	
Second Failover SipServer	
Prefer Primary SIP Server	<input checked="" type="radio"/> No <input type="radio"/> Yes
Current SIP Server	10.13.0.12
DHCP SIP Server	<input checked="" type="radio"/> No <input type="radio"/> Yes
Outbound Proxy	
Backup Outbound Proxy	
* SIP Transport	<input checked="" type="radio"/> UDP <input type="radio"/> TCP <input type="radio"/> TLS
NAT Traversal	<input type="radio"/> No <input checked="" type="radio"/> No, but send keep alive <input type="radio"/> STUN
DNS Mode	<input checked="" type="radio"/> A Record <input type="radio"/> SRV <input type="radio"/> NAPTR/SRV
Call Message Format	Regular
Transfer Release Trigger:	NOTIFY with 200OK
SIP Registration	<input type="radio"/> No <input checked="" type="radio"/> Yes
Unregister On Reboot	<input checked="" type="radio"/> No <input type="radio"/> Yes
Register Expiration	15
Outgoing Call Without Registration	<input type="radio"/> No <input checked="" type="radio"/> Yes
RPort	<input checked="" type="radio"/> No <input type="radio"/> Yes
RFC 2543 Hold	<input type="radio"/> No <input checked="" type="radio"/> Yes
<input type="button" value="SaveSet"/> <input type="button" value="Restart"/>	

3. Fill the Primary SIP Server and other profile information.
4. Select Yes for the DHCP SIP Server and select the SIP Transport.
5. Click  to save the configuration.
6. Click Account→ Basic.
7. Select the desired account from the pull-down list of Account in the Account field.

<b>Account</b>	Account 1
Account Status	012@10.13.0.12:5060 : Registered; UDP
* Account Active	<input type="radio"/> No <input checked="" type="radio"/> Yes
Profile	Profile 1
Label	<input type="text"/> ?
* SIP User ID	012 ?
* Authenticate ID	012 ?
* Authenticate Password	..... ?
Name	<input type="text"/> ?
Local SIP Port	5060 ?
Use Random Port	<input checked="" type="radio"/> No <input type="radio"/> Yes
Voice Mail UserID	<input type="text"/> ?
Dial Plan	<input type="text"/>
Eventlist BLF URL	<input type="text"/>
Shared Line	Disable
SCA Barge-In	Disable ?
Direct Call Pickup Code	<input type="text"/>
Group Call Pickup Code	<input type="text"/>
Feature Key Sync	Disable
<input type="button" value="SaveSet"/> <input type="button" value="Restart"/>	

8. Select Yes for Account Active.

9. Select the desired Profile.

10. Fill the SIP User ID, Authenticate ID, Authenticate Password and other account information.

11. Click  to save the configuration.

**Note:**

1. All fields with \* must be filled. If changed, it requires a phone restart.
2. Account Status says the account registered successfully or not.

## Idle Screen

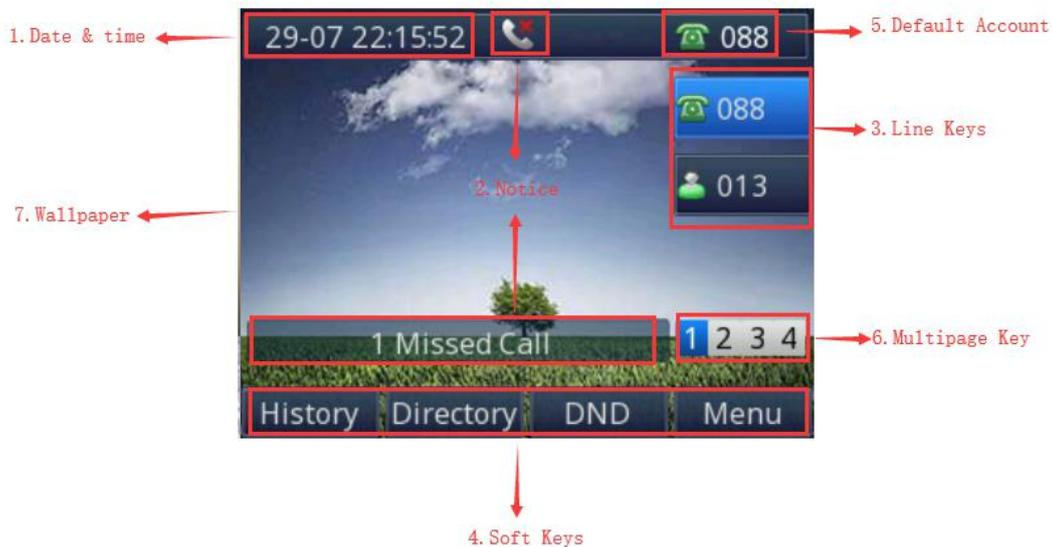

Name	Description
1. Date & Time	It is the area that displays the current set date and time of the phone.
2. Notice	It is the area to display the phone's notifications such as missed calls, SMS, do not disturb mode and many more. For more info, see <a href="#">Icon Preview</a> .
3. Line Keys	This area shows the line key labels. The Line keys can also be used for other function keys. For more info, you can refer to <a href="#">Line Keys</a>
4. Soft Keys	This area shows the soft key labels. The default soft key labels are "History", "Directory", "DND" and "Menu". For more info, see <a href="#">Programmable Key</a>
5. Default Account	This shows the current use account. User can use  to change the default use account.
6. Multipage Key	UC921(G) support 12 keys, you can configure different types. You can view and use these keys by pressing the multipage key.
7. Wallpaper	This shows the current wallpaper picture. You can also change it. For more info, you can refer to <a href="#">Wallpaper</a> .

# Getting Familiar with Your Phone

## Hardware Components Preview

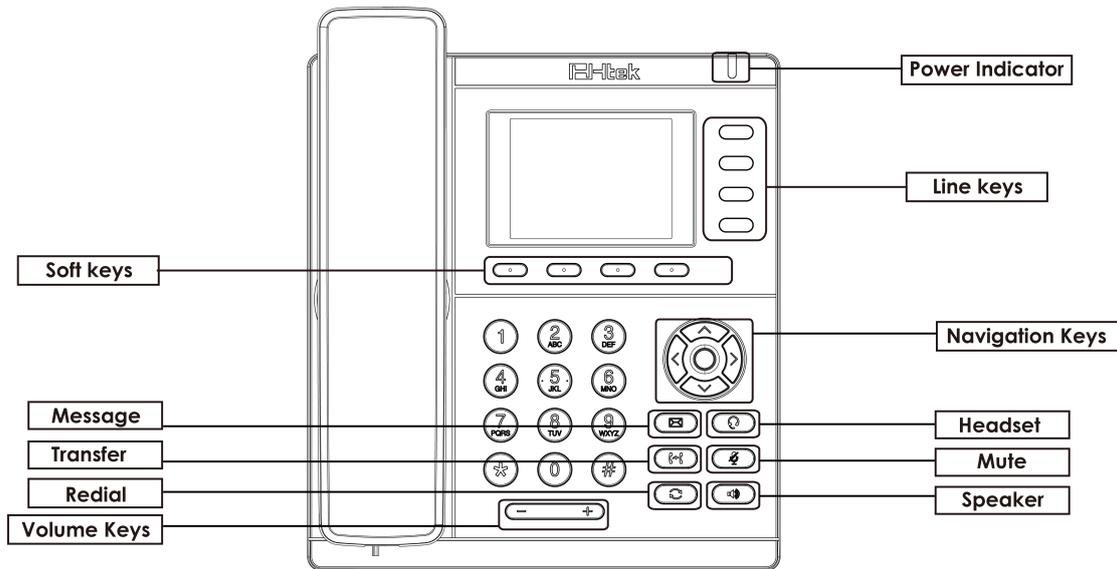

Item	Description
LCD screen	To present all information about the date& time, accounts, soft keys, messages, calls and other some information.
Power Indicator LED	To indicate the power status
Line Keys	The phone supported up to 4 accounts 1. Steady green: during a call.. 2. Blink red: a call incoming
Soft Keys	Labels automatically to identify their context-sensitive features.
Navigation Keys	 OK.  <b>Up arrow key:</b> To move up of the selection shows on the screen.  <b>Right arrow key:</b> To move right of the selection shows on the screen.



**Left arrow key:** To move left of the selection shows on the screen.



**Down arrow key:** To move down of the selection shows on the screen.

Line Keys

To be configured as different function as:

1. Line
2. Speed Dial
3. BLF
4. BLF List
5. Voice Mail
6. Direct Pickup
7. Group Pickup
8. Call Park
9. Intercom
10. DTMF
11. Prefix
12. Local Group
13. XML Group
14. XML Browser
15. LDAP
16. Network Directories
17. Conference
18. Forward
19. Transfer
20. Hold
21. DND
22. Redial
23. Call Return
24. SMS
25. Record
26. URL Record
27. Paging
28. Group Listening
29. Public Hold
30. Private Hold
31. Hot Desking
32. ACD
33. Zero Touch
34. URL

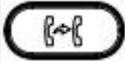
	<p>35. Network Group</p> <p>36. Multicast Paging</p> <p>37. Group Call Park</p> <p>38. CallPark Retrieve</p> <p>39. Shared Line</p> <p>The LED lights status when set as Shared line:</p> <p>Stay green: Idle</p> <p>Stay red: Busy</p> <p>Blinked green: Ring Back</p> <p>Blinked red: A call incoming</p> <p>Steady orange: During a call</p> <p>Blinked orange: Public Hold</p> <p>Blinked green: Private Hold</p> <p>Light Drown: Unregistered</p> <p>40. Broadsoft Directory</p>
Alphanumeric Keypad	To enter the phone numbers, letters and so on.
Message	 <p>To indicator the New message, and press to read.</p>
Transfer	 <p>To transfer a call to a third party.</p> <p>To enable or disable Forward feature during the idle page.</p>
Redial	 <p>To dial the previous dialed number.</p> <p>To act as send key.</p>
Volume Keys	 <p>To decrease the volume.</p>  <p>To increase the volume.</p>
Headset	 <p>To indicate that the phone is or not in Headset mode.</p>
Mute	 <ol style="list-style-type: none"> <li>1. To mute the voice during the call (Red light).</li> <li>2. To un-mute the call.</li> </ol>
Speaker	 <p>Press this button to place a call in hands-free mode.</p>

## Icon Preview

Icon	Description
	Network down
	Line(Registered succeed)
	Line (Unregistered)
	Line(Ringing)
	Speed Dial
	BLF
	BLF(Ringing)
	BLF(Talking)
	Speakerphone mode
	Handset mode
	Headset mode
	Voice messages

	<b>Text message</b>
	Mute
	Do Not Disturb
	Volume is 0
	SRTP
	Hold
	Dialed calls
	Received calls
	Missed calls
	Forward calls
	Conference
	Keypad locked
	Pick up
	Call Park

	<b>Intercom/Paging</b>
	DTMF
	Prefix
	XML Group
	Local Group
	XML Browser
	LDAP
	Broadsoft Group
	Conference
	Forward
	Transfer
	Hold
	Redial
	Call Return
	Record
	<b>Stop Recording</b>
	Group Listening

	Shared Line
	Other Functions

## LED Instruction

This part mainly instructs the LED status. The Power LED Status describe on the premise that the LED setting all set as Yes. For LED status setting, please refer to: [LED Status Setting](#)

### Power Indicator LED

LED Status	Description
Blinked green	Ringing or have missed call
Steady Green	Idle status (Power on)
Off	Powered off.

### Line LED (Line Key set as Line)

LED Status	Description
Steady Green	Hold
Steady Green	Off hook or during a conversation.
Blinked red	Ringing.
Off	Idle status

### BLF or BLF List Key LED ( Line/Line Key set as BLF)

LED Status	Description
Steady Green	Idle status for the monitored line
Steady Red	The monitored line is calling or during a call
Blinked red	The monitored line is ringing.
Off	All other unknown status

## Shared Line LED

LED Status	Description
off	Idle status
Stay green	a member of the SCA group in off-hook status
Stay red	Other member of the SCA group's led status when a member of the SCA group in off-hook status
Blinked green every 500ms	a member of the SCA group in Private hold status.
Stay red	Other member of the SCA group's led status when a member of the SCA group in Private hold status
Blinked green every 500ms	a member of the SCA group in public hold status
Blinked red every 500ms	Other member of the SCA group's led status when a member of the SCA group in public hold status
Blinked green every 500ms	a member of the SCA group in progressing status
Stay red	Other member of the SCA group's led status when a member of the SCA group is in progressing status.
Blinked red every 100ms	Alerting
Stay green	a member of the SCA group in active status when there is an incoming call designated for the SCA group
Stay red	Other member of the SCA group's led status when a member of the SCA group in active status

## Other Key Led

Key	Description
Headset Key	When using in headset mode, the led is steady green or the LED is off.
Message Key	Blinked green when there is a new message or the LED is off.
Mute Key	Red when muting the call, or the LED is off.

## User Interface

There are two ways to customize specific configurations on your IP phone:

- The user interface on the IP phone
- The user interface in a web browser on your PC

The hardware components keypad and LCD screen constitute the phone user interface, which allows the user to execute all call operation tasks and basic configuration changes directly on the phone. In addition, you can use the web user interface to access all configuration settings. In many instances, it is possible to use both the phone user interface and the web user interface to operate the phone and change settings. However, in some instances, it is only possible to use the phone or the web user interface.

### Phone Interface Overview

Option		
Status	Information	
	Network	
	Accounts	
Features	Call Forward	
	Function	
	More Key see <a href="#">Line Key Overview</a>	
	# as Send	
	Hot Line	
	Anonymous Call	
	DND	
Directory	History	
	All Contacts	
	Local Contacts	
	LDAP(When you use LDAP, It will display)	
History	BlackList	
	Local	
Messages	CallLog	
	Voice Mail View and Set.	
Settings	Text Message View and Set.	
	Basic	Language
		Time & Date
		Format
		DHCP Time
		Ring Tone
		Headset
		Font Size
Text Scroll		

	Advanced	Accounts
		Network
		Settings
		AP
Display		Display Mode
		Wallpaper
		Screensaver
Others		Factory Function
		System Restart
		Device Reboot
		Pcap Feature

## Line Key Function Overview

<a href="#">Line</a>
<a href="#">Speed Dial</a>
<a href="#">BLF</a>
<a href="#">BLF List</a>
<a href="#">Voice Mail</a>
<a href="#">Direct Pickup</a>
<a href="#">Group Pickup</a>
<a href="#">Call Park</a>
<a href="#">Intercom</a>
<a href="#">DTMF</a>
<a href="#">Prefix</a>
<a href="#">Local Group</a>
<a href="#">XML Group</a>
<a href="#">XML Browser</a>
<a href="#">LDAP</a>

<a href="#">Network Directories</a>
<a href="#">Conference</a>
<a href="#">Forward</a>
<a href="#">Transfer</a>
<a href="#">Hold</a>
<a href="#">DND</a>
<a href="#">Redial</a>
<a href="#">Call Return</a>
<a href="#">SMS</a>
<a href="#">Record</a>
<a href="#">URL Record</a>
<a href="#">Paging</a>
<a href="#">Group Listening</a>
<a href="#">Public Hold</a>
<a href="#">Private Hold</a>
<a href="#">Hot Desking</a>
<a href="#">ACD</a>
<a href="#">Zero Touch</a>
<a href="#">Multicast Paging</a>

## Basic Setting Configuration

This part will mainly introduce the basic configuration as the Time, Language, and Volume...

### General Settings

### Web Login

1. Get the IP address: Press Menu→ Status→ Information.



Information	
1.Model:	UC921G
2.IPV4:	10.3.4.24
3.MAC:	00:1f:c1:1d:87:3d
4.FW(IMG):	 2.0.4.6.24(2019-0..
5.FW(BOOT):	 2.0.4.4(2018-01-..
<input type="button" value="Back"/>	

2. Input the IP Address in the web browser.
3. Input the user name (default is admin), password (default is admin).
4. Login successfully.

**● Version** [?](#)

Product Model	UC921G
Firmware Version	BOOT--2.0.4.4(2018-01-20 13:34:00) IMG--2.0.4.6.24(2019-07-02 17:28:00) ROM--2.0.4.6.24(2019-07-02 17:28:00) DSP--9.0.3(Patch 1.0.16)

**● Account Status** [?](#)

Account1	012@10.13.0.12:5060 : Registered; UDP
Account2	Disabled
Account3	Disabled
Account4	Disabled
Account5	Disabled
Account6	Disabled
Account7	Not Registered
Account8	Not Registered

**● Network** [?](#)

IP Mode (IPv4/IPv6)	IPv4
Device Type	Bridge
MAC Address	00:1f:c1:1d:87:3d
Current Time	05-07 04:45:16

**● IPv4 Setting**

WAN Port Type	DHCP
WAN IP Address	10.3.4.24
Subnet Mask	255.255.0.0
Gateway	10.3.0.1
Primary DNS	192.168.0.230
Secondary DNS	

**● Memory Free** 26508 KB**● System Up Time** 0 day(s) 0 hour(s) 36 min(s) 50 sec(s)**● Restart**

**Note:**

The PC and phone should be in the same segment.

When registering the accounts in web and the server port is not “5060”, the “SIP Server” should be set as “SIP Server’s IP address: server port”, for example, “192.168.0.122:5090”.

## Administrator Password

The password is mainly used for login the web interface or set the advanced settings through phone interface. And the default password of the administrator is: **admin**

**To change to password via Phone interface**

1. Press Menu→ Settings→ Advanced Setting→ Password (default: admin)→ Phone Setting→ Set Password
2. Enter the Current PWD (password), New PWD and confirm the new password.
3. Press Save soft key or  to save the new password.

**To change to password via Web interface**

1. Management→ Password
2. Fill the value
3. Click  to save the configuration.

User Type	<input type="text" value="admin"/>
Current Password	<input type="text"/> (Max length 26)
New Password	<input type="text"/> (Max length 26)
Confirm Password	<input type="text"/> (Max length 26)

**Note:**

When you use the web interface: user name: admin password: admin(default)

## Display Mode

This phone support two Display mode: Text and Icon.

**Icon Mode:** all Items are shown same as the main with Icon.

**Text Mode:** Only the 8 main items will be shown as icon, and others all text description.

**To Configure Display mode via Phone interface:**

1. Press Menu→ Display→ Display Mode
2. Select Text or Icon
3. Press Save soft key to save the configuration.

**To Configure Display mode via Web interface:**

1. Login web interface, and click Setting→ Preference

Display Mode	<input type="radio"/> Icon Mode
	<input checked="" type="radio"/> Text Mode

2. Select Icon Mode or Text Mode for the Display Mode

3. Click  to save the configuration.

## Language

The default Phone interface language is English.

**To change the language via Phone interface**

1. Press Menu→ Settings→ Basic Setting→ Language.



2. Select the necessary one.

3. Press  or Save soft key to save the configuration.



#### To change the language via Web interface

1. Setting→ Preference→ Web Language & LCD Language

2. Select the necessary one.

3. Press  to save the configuration.

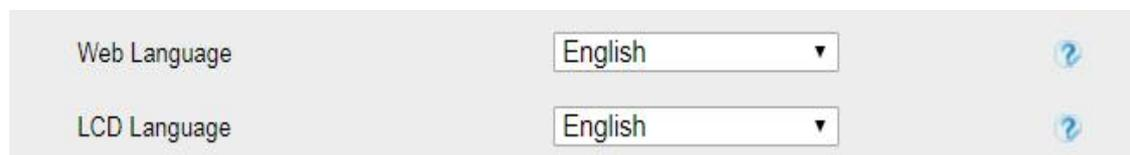

#### Note:

All languages may not be available for selection. The available languages depend on the language packs currently loaded to the IP phone.

## Wallpaper

To change wallpaper, go by the following steps:

**To change the wallpaper via Phone interface:**

1. To press Menu→ Display→ Wallpaper

2. Press  and  or press Switch soft key to display the different pictures.

3. Press  or Save soft key to save the selected picture as the wallpaper.



**To change the wallpaper via Web interface:**

1. Click Setting→ Preference

2. Select the desired wallpaper picture to upload.

3. Click  to save the setting.



**To delete the wallpaper via Web interface:**

1. Click Setting→ Preference

2. Select the desired wallpaper to delete.

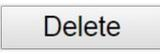
3. Click  to save the setting.

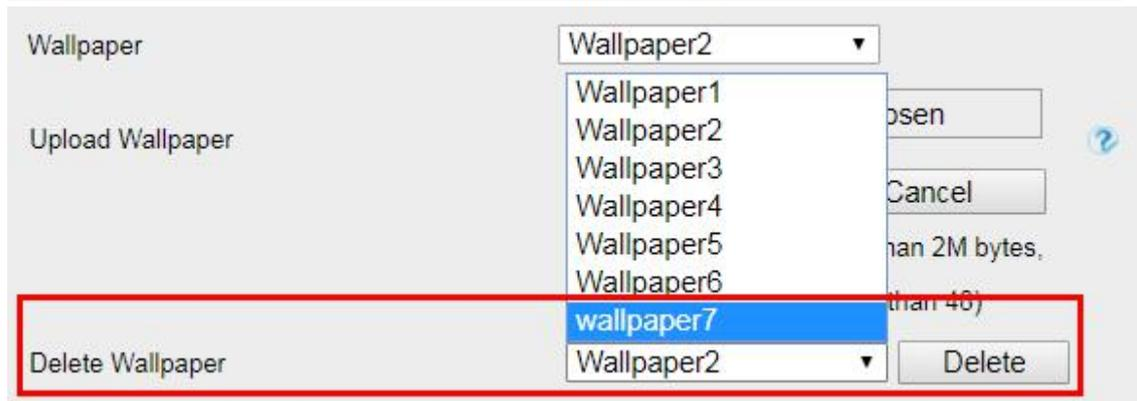
**Note:**

System wallpaper (Wallpaper1-Wallpaper6) cannot be deleted and only color IP Phone support upload wallpaper.

## Screen Saver

There are four types of screen saver: Time & Logo, Time Only, Photo Switch and Static Photo.

**Time & Logo:** when the screensaver works, it will show Time and logo in turns.

**Time Only:** when the screensaver works, it will only show Time

**Photo Switch:** all screensaver pictures display one by one.

**Static Photo:** Only the selected picture will display as screensaver.

**Text Logo:** It works with the **Time & Logo**, when enter the value, it will display the time and the entered value in turns.

**To enable screen saver via Phone interface:**

1. To press Menu→ Display→ Screensaver...

2. Press  and  or press Switch soft key to choose the Time-out as 1 min or 2/5/10/30 minute.

3. Press  or Save soft key to save the selected configuration.

4. Enter the Screensaver Type to choose one of the type: Time & Logo, Time Only, Photo Switch and Photo.

5. Press  or Save soft key to save the selected configuration.



**To disable screen saver via Phone interface**

1. To press Menu→ Display→ Screensaver...

2. Press  and  or press Switch soft key to choose the Time-out as off.

3. Press  or Save soft key to save the selected configuration.

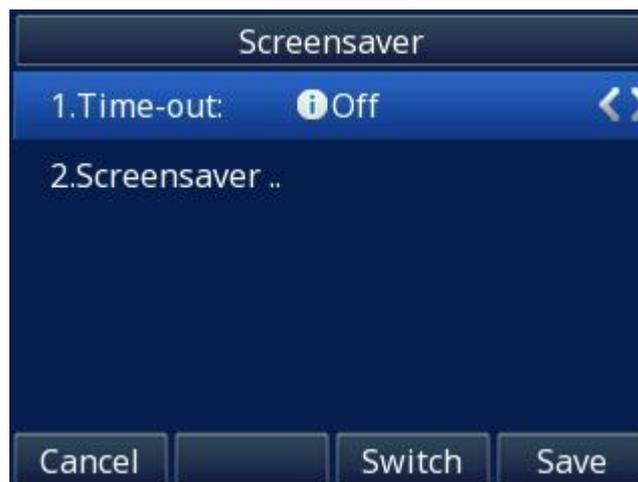

**To upload screen saver via Web interface:**

1. Setting→ Preference

2. Choose the picture wanted to use as screen saver

3. Click  to save the upload picture

**To delete upload screen saver photo via Web interface:**

1. Setting→ Preference
2. Select the photo that to delete.
3. Click  to delete the photo.

**Note:**

**System Screen Photo (ScreenSaver1-ScreenSaver3) cannot be deleted and only color IP Phone support upload wallpaper.**

**To custom text logo via Web interface:**

1. Click Setting→ Preference.
2. Choose the Screen Time Out as 1 min or 2/5/10/30 minute and choose the ScreenSaver Type as time & logo.
3. Enter the desired value in the Text Logo field.
4. Click  to save the configuration.

**To wake up screen saver via Web interface:**

1. Setting→ Preference
2. Choose Dial First Digit: Screensaver Wakes up or Screensaver Wakes up and Dial
3. Click  to save the configuration.

Dial First Digit

- Screensaver Wakes up
- Screensaver Wakes up and Dial

**Note:**

1. The upload Photo size should be less than 2MB, name length should be less than 48 characters, and the File name should be letters, numbers or underline '\_' and photo number should be less than 9.
2. The default screensaver photos cannot be deleted.
3. You can only upload screen photos in format of '.bmp' and '.jpg'.

## Backlight

**To set Backlight via Web interface:**

1. Click Setting→ Preference
2. Enter the time for Backlight time (In seconds).  
The default is 0, which means Backlight is always on.
3. Click  to save the configuration.

Backlight Time

 **Note:****Backlight Time refers to the time into the backlight**

## Time and Date

Time and date is displayed on the idle page, and it can be set automatically by SNTP server or manually by manual setting.

**To configure the time and Date by SNTP setting via Phone interface**

1. Press Menu→ Settings→ Basic Setting→ Time & Date→ SNTP Settings
2. Press  or  to change the Time zone.
3. Fill the NTP Server1, NTP Server2, and select the mode of Daylight Saving.
4. Press  or Save soft key to save the configuration.



#### To configure time and date manually via Phone interface

1. To press Menu→ Settings→ Basic Setting→ Time & Date→ Manual
2. Press  and  to change the right time, or you can input the right time.
3. Press  or Save soft key to save the configuration.

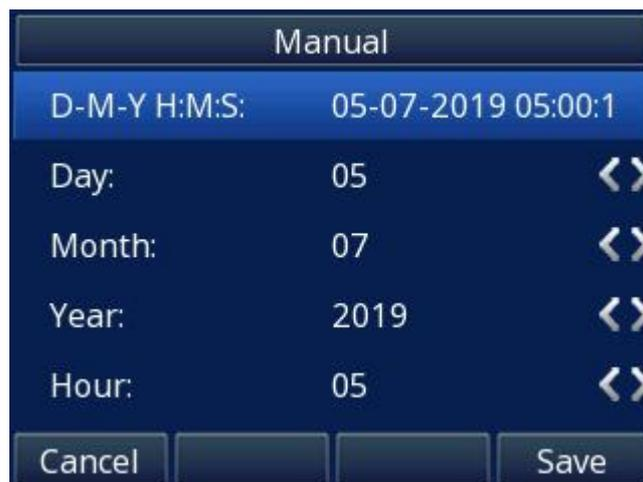

#### To configure the Time & Date Format via Phone interface

1. Press Menu→ Settings→ Basic Setting→ Time & Date Format
2. Press  and  to change between 12 Hour or 24 Hour time display.
3. Press  and  to change date display format.
4. Press  or Save soft key to save the configuration.



#### To configure the DHCP time via Phone interface

1. To press Menu→ Settings→ Basic Setting→ DHCP time
2. Press  and  to change between Disable and Enable.
3. Press  or Save soft key to save the configuration.



#### To configure the DHCP Option 100 via Web interface:

1. Login  
Login name: admin, password: admin(default)
2. Setting→ Date & Time→ DHCP Option 100
3. Select Yes for the DHCP Option 100
4. Click  to save the configuration

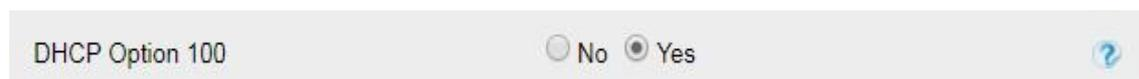

#### To configure the NTP Server via Web interface

1. Login  
Login name: admin, password: admin(default)

2. Setting→ Date & Time→ NTP Server
3. Fill the value in the blank.
4. Click  to save the configuration.

NTP Server	<input type="text" value="time.windows.com"/>	<a href="#">?</a>
Backup NTP Server	<input type="text"/>	<a href="#">?</a>

**To change the Time Zone and Date Display Format via Web interface**

1. Setting→ Date & Time
2. Select the necessary one.
3. Click  to save the configuration.

DHCP Option 100	<input checked="" type="radio"/> No <input type="radio"/> Yes	<a href="#">?</a>
DHCP Time	<input checked="" type="radio"/> No <input type="radio"/> Yes	<a href="#">?</a>
Time Zone	<input type="text" value="-5 United States-Eastern Time"/>	<a href="#">?</a>
NTP Server is Covered with DHCP	<input checked="" type="radio"/> No <input type="radio"/> Yes	<a href="#">?</a>
NTP Server	<input type="text" value="time.windows.com"/>	<a href="#">?</a>
Backup NTP Server	<input type="text"/>	<a href="#">?</a>
Current Time	04-01 01:53:29	<a href="#">?</a>
SIP Date Override Time	<input checked="" type="radio"/> No <input type="radio"/> Yes	<a href="#">?</a>
Account(SIP Date Override Time)	<input type="text" value="Account 1"/>	<a href="#">?</a>
Daylight Saving Time	<input checked="" type="radio"/> Disable <input type="radio"/> Enable <input type="radio"/> Auto	<a href="#">?</a>
Time Format	<input checked="" type="radio"/> 24 Hour <input type="radio"/> 12 Hour	<a href="#">?</a>
Date Display Format	<input type="radio"/> Year - Month - Day <input type="radio"/> Month - Day - Year <input checked="" type="radio"/> Day - Month - Year	<a href="#">?</a>

**To change the SIP Date Override Time via Web interface**

1. Setting→ Date & Time→ SIP Date Override Time
2. Select Yes or No for SIP Date Override Time .

3. Click  to save the configuration.

SIP Date Override Time  No  Yes [?](#)

**To change the Account via Web interface**

1. Setting→ Date & Time→ Account.
2. Select Yes for SIP Date Override Time and select desired Account.
3. Click  to save the configuration.

SIP Date Override Time  No  Yes [?](#)

Account(SIP Date Override Time) Account 1 ▾  
Account 1 [?](#)

Daylight Saving Time Account 2  Disable  Auto [?](#)

Time Format Account 3 2 Hour [?](#)

Date Display Format Account 4 Day [?](#)

Account 5 Year

Account 6 Year

Account 7 Year

Account 8 Year

**To change the Daylight Saving Time via Web interface**

1. Setting→ Date & Time→ Daylight Saving Time
2. Select Disable or Enable or Auto for Daylight Saving Time.
3. Click  to save the configuration.

Daylight Saving Time  Disable  Enable  Auto [?](#)

**Note:**  
**If the IP Phone cannot obtain the time and date from the Simple Network Time Protocol (SNTP) server, please contact your system administrator for more information.**

**Daylight Saving Time**

Daylight Saving Time (DST) is the practice of temporary advancing clocks during the summertime so that evenings have more daylight and mornings have less. Typically, clocks are adjusted forward one hour at the start of spring and backward in autumn. Many countries have used the DST at various times, details vary by location. The DST can be adjusted automatically from the time zone configuration. Typically, there is no need to change this setting

## LED Status Setting

The LED Status setting mainly defines the power indicator LED.

**To configure LED Status via Web interface:**

1. Click Setting→ Preference

2. Select Yes or No for Power Status, Ringing Status, Miss Calls Status and Voice Message Status.

3. Click  for the setting.

For the LED status description, see: LED Instruction [Power Indicator LED](#)

LED Status Setting:

Power Status	<input checked="" type="radio"/> Yes	<input type="radio"/> No
Ringing Status	<input checked="" type="radio"/> Yes	<input type="radio"/> No
MissCalls Status	<input type="radio"/> Yes	<input checked="" type="radio"/> No
Voice Message Status	<input type="radio"/> Yes	<input checked="" type="radio"/> No

## Key as Send

**To configure # Key as Send via Phone interface:**

1. Press Menu→ Features→ Key as Send
2. Press  and  key to select the Enable choice.
3. Press  or Save soft key to save the configuration

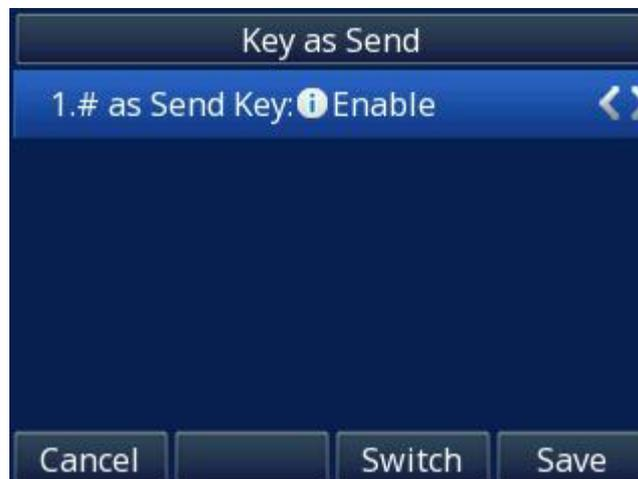

**To cancel # Key as Send via Phone interface:**

1. Press Menu→ Features→ Key as Send
2. Press  and  key to select the Disable choice.
3. Press  or Save soft key to save the configuration

**To configure # Key as Send via Web interface:**

1. Click Setting→ Preference
2. Select Yes or No for Use # As Dial Key.
3. Click  for the setting.

Use # As Dial Key

 No  Yes 

## Network Setting

Htek IP Phone supports IPv4, IPv6, IPv4&IPv6. They have three mode of Network: DHCP, Static, and PPPoE. The default mode is DHCP, it will obtain IP address and other information automatically.

If your phone cannot contact a DHCP server for any reason, you need to configure a static IP address manually.

When switch DHCP, Static IP Address and PPPoE to each other, or change the Static IP on webpage, it will show the warning of restart as following.

Network settings have been changed, Are you sure reboot the phone to save changes?



## IPv4

If you set IP Mode to IPv4, IP phone will use IPv4 address. IPv4 has three network modes: DHCP, Static, and PPPoE

### To configure IPv4 via Phone interface:

1. Press Menu → Settings → Advanced Setting (password: admin) → Network → WAN Port → IP Port Mode.

2. Press  or  to change the IP Port Mode..

3. Press  or Save soft key to save the configuration.

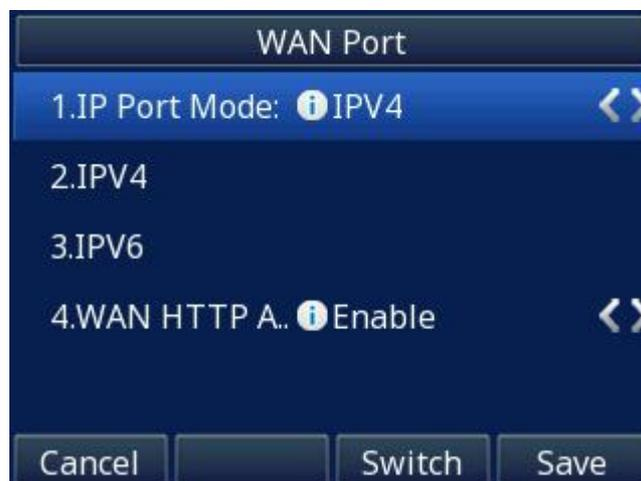

### To configure IPv4 via Web interface:

1. Click Network→ Basic→ Internet Port
2. Select IPv4 for Internet Port
3. Click  for the setting.

**To configure DHCP via Phone interface:**

1. Press Menu→ Settings→ Advanced Setting (password: admin)→ Network→ WAN Port→ IPv4→ DHCP mode.
2. Click Save and restart the phone.

**To configure a static IP address via Phone interface:**

1. Press Menu→ Settings→ Advanced Setting (password: admin)→ Network→ WAN Port→ IPv4→ Static mode.
2. Enter the parameters: IP, Netmask, Gateway, Pri.DNS(primary DNS), Sec.DNS (second DNS) in the corresponding fields.

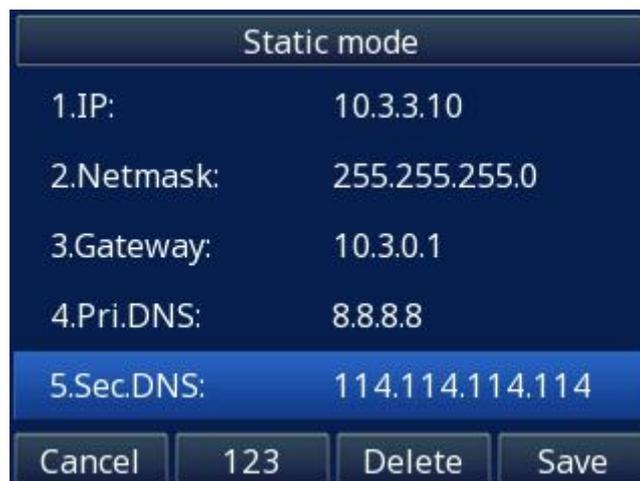

3. Click Save and restart the phone.

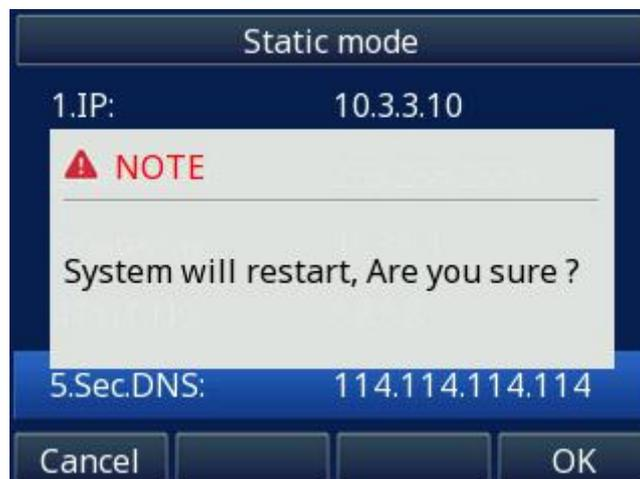

4. Press the OK soft key to accept the change or the Cancel soft key to cancel. If you are using an xDSL modem, you can connect your phone to the Internet via PPPoE mode. You

can set a WAN port to be a PPPoE port. The PPPoE port will perform a PPP negotiation to obtain the IP address. Contact your system administrator for the PPPoE user name and password.

**To configure PPPoE via Phone interface:**

1. Press Menu→ Settings→ Advanced Setting (password: admin)→ Network→ WAN Port→ PPPoE mode.
2. Enter the User ID and Password
3. Click Save and restart the phone.



PPPoE mode

1.User ID: 8465862

2.Password: \*\*\*\*

Cancel 2aB Delete Save

**To configure Network via Web interface:**

1. Click Network→ Basic→ IPv4 Setting
2. Select the desired Type: DHCP, Static IP Address or PPPoE
3. Fill the necessary information.
4. Click  and restart the phone.

● **IPv4 Setting**

DHCP ?

DHCP HostName

DHCP Domain

DHCP Vendor Class Id

DHCP User Class

Static IP Address ?

IP Address  .  .  .

Subnet Mask  .  .  .

Default Gateway  .  .  .

Static DNS  No  Yes

Primary DNS  .  .  .

Secondary DNS  .  .  .

PPPoE ?

Account ID

PassWord

Service Name

Preferred DNS Server  .  .  .

## IPv6

If you set IP Mode to IPv6, IP phone will use IPv6 address. IPv6 has two network modes: DHCP, Static IP Address.

### To configure IPv6 via Phone interface:

1. Press Menu → Settings → Advanced Setting (password: admin) → Network → WAN Port → IP Port Mode.

2. Press  or  to change the IP Port Mode..

3. Press  or Save soft key to save the configuration.



**To configure IPv6 via Web interface:**

1. Click Network→ Basic→ Internet Port
2. Select IPv6 for Internet Port
3. Click  for the setting.

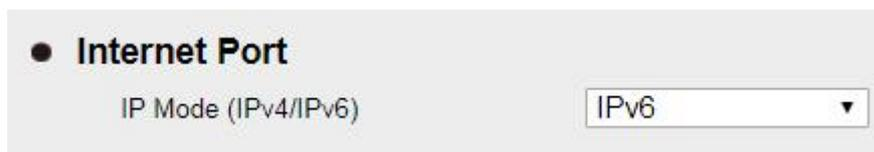

**To configure DHCP via Phone interface:**

1. Press Menu→ Settings→ Advanced Setting (password: admin)→ Network→ WAN Port → IPv6→ DHCP mode.
2. Click Save and restart the phone.

**To configure a static IP address via Phone interface:**

1. Press Menu→ Settings→ Advanced Setting (password: admin)→ Network→ WAN Port→ IPv6→ Static mode.
2. Enter the parameters: IP, IPV6 Prefix, Gateway, Pri.DNS(primary DNS), sec.DNS (second DNS) in the corresponding fields.

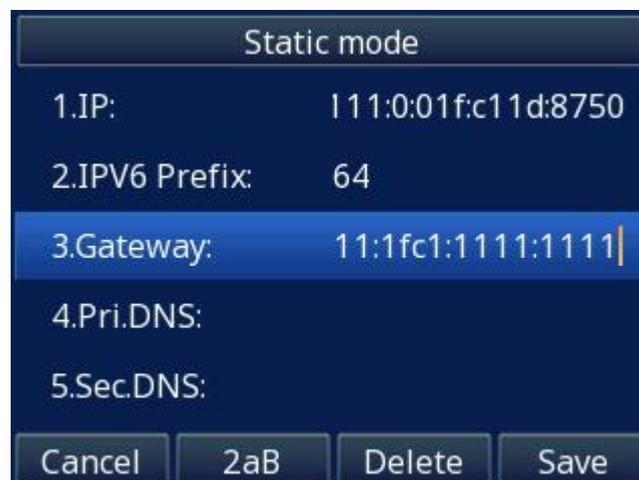

3. Click Save and restart the phone.

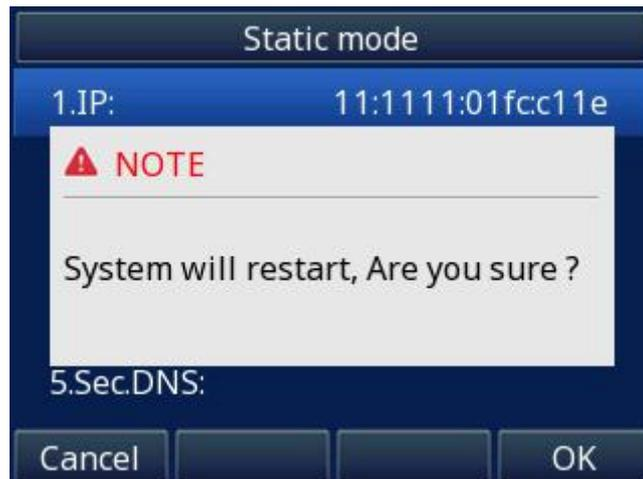

**To configure Network via Web interface:**

1. Click Network→ Basic→ IPv6 Setting
2. Select the desired Type: DHCP, Static IP Address.
3. Fill required fields.
4. Click  and restart the phone.

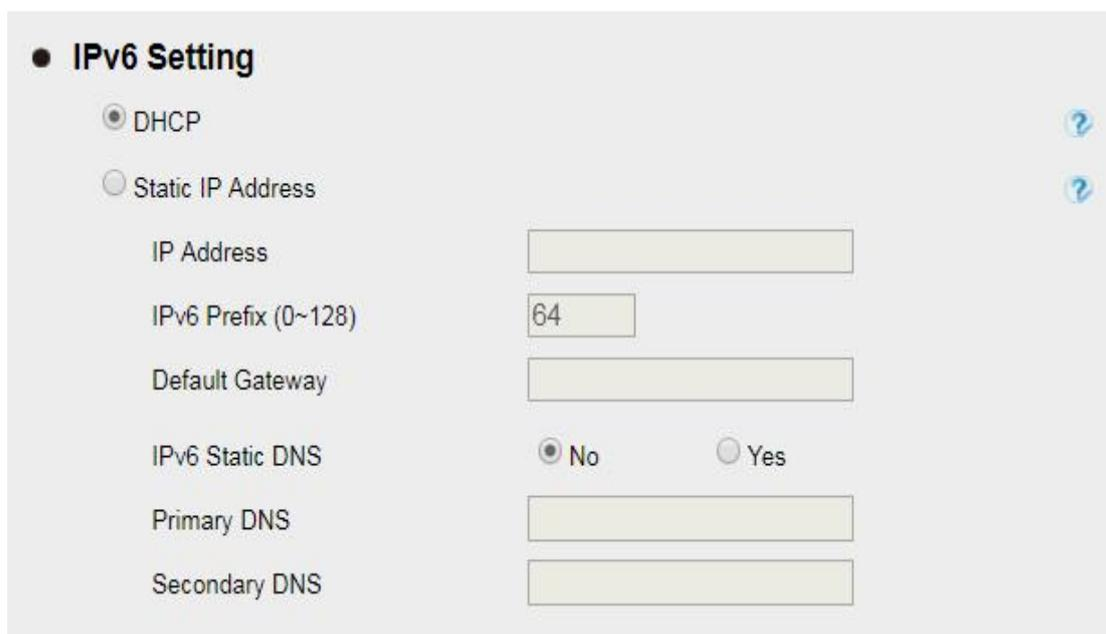

## IPv4&IPv6

If you set IP Mode to IPv4&IPv6, IP phone will support both IPv4 and IPv6 address. The settings of DHCP, Static, and PPPoE are same as above.

**To configure IPv4&IPv6 via Phone interface:**

1. Press Menu→ Settings→ Advanced Setting (password: admin)→ Network→ WAN Port→ IP Port Mode.

2. Press  or  to change the IP Port Mode.
3. Press  or Save soft key to save the configuration.



**To configure IPv4&IPv6 via Web interface:**

1. Click Network→ Basic→ Internet Port
2. Select IPv4&IPv6 for Internet Port
3. Click  for the setting.



**Note:**

Wrong network parameters may result in inaccessibility of your phone and may also have an impact on your network performance. For more information about these parameters, contact your system administrator.

## PC Port

Two modes for PC Port: bridge and router.

**To configure Bridge via Phone interface:**

1. Press Menu→ Settings→ Advanced Setting (password: admin)→ Network→ PC Port→ Bridge mode.
2. Click Save
3. Click the OK button, then the phone will reboot.

**To configure Router via Phone interface:**

1. Press Menu→ Settings→ Advanced Setting (password: admin)→ Network→ PC Port→ Router mode.
2. Enter the IP, Netmask and DHCP server
3. Click Save
4. Click the OK button, then the phone will reboot

**To configure Bridge via Web interface:**

1. Click Network→ PC Port
2. Select As Bridge
3. Click  and then click , the phone will reboot automatically.

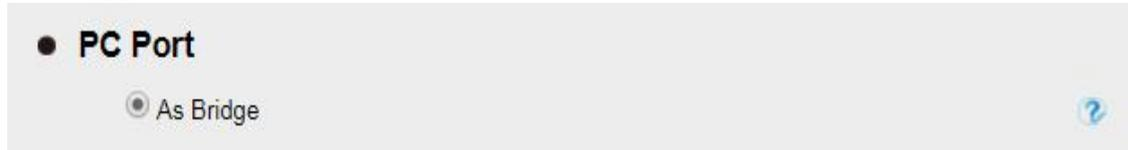

**To configure Router via Web interface:**

1. Click Network→ PC Port
2. Select As Router
3. Fill the IP Address and other necessary information.
4. Click  and then click , the phone will reboot automatically

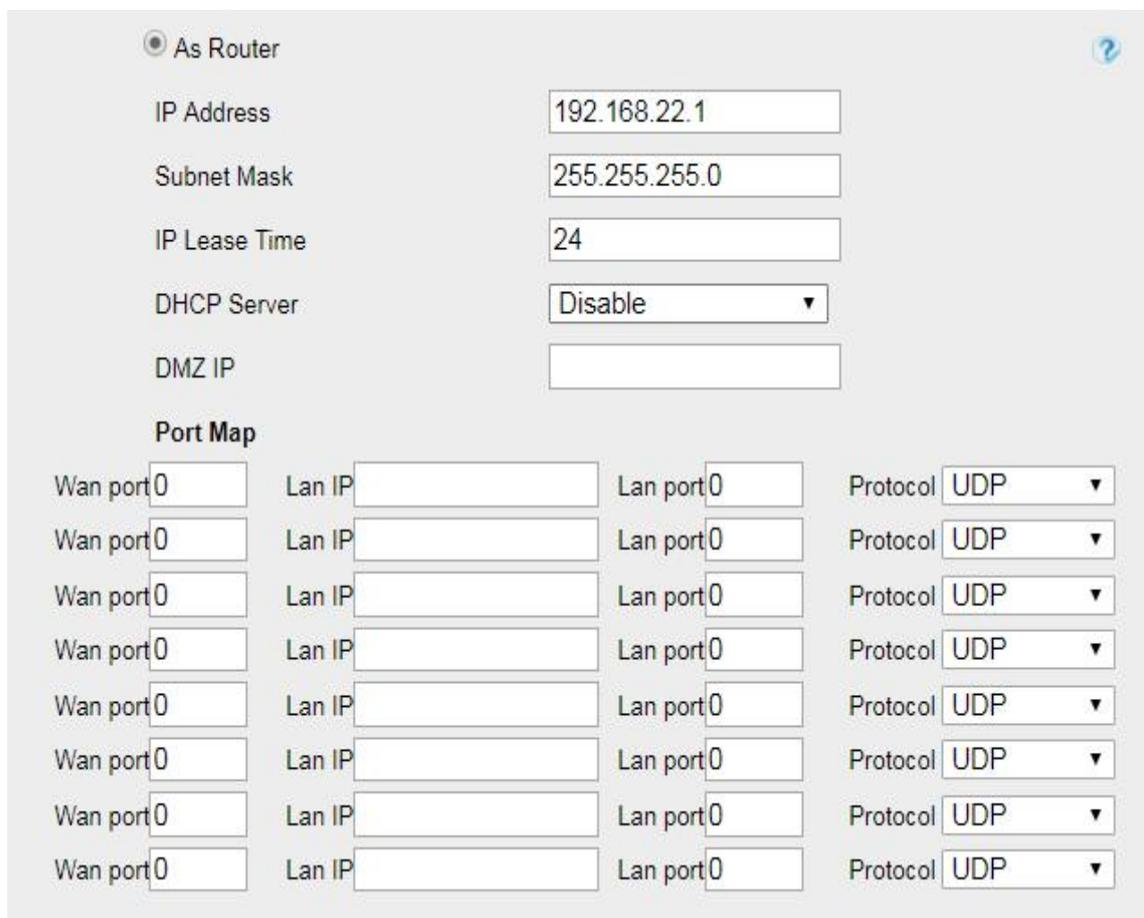

## Contact Setting

This section provides the operating instructions for managing contacts. The topics include:

- Local Directory
- Remote Phonebook

- LDAP
- Search Contact

## Local Directory

In the directory, you can add or delete your friends, business partner or anyone others' phone No., so you will not forget their number. Or put some anonymous phone No. in the blacklist to prevent from being disturbed. The local Directory can add up to 1000 contacts.

### A. To add contacts list into local directory

#### To add contacts manually via Phone interface

1. Press Menu→ Directory→ Local Contacts
2. Press Add soft key.
3. Enter the necessary information as Name, Phone number...
4. Press Save soft key or  to add the contacts successfully.



#### To add contacts from history via Phone interface:

1. Press History soft key or press Menu→ History→ Local History→ All/ Missed/ Received/ Dialed/ Forwarded Calls
2. Press  and  to select the targeted one. (Press  and  switched among the All Calls, Missed Calls, Received Calls, Dialed Calls and Forwarded Calls).
3. Press Option soft key→ Add to Contacts
4. Edit the necessary information as Name, Phone number...
5. Press Save soft key or  to add the contacts successfully.

**To add contacts via Web interface:**

1. Click Directory→ Directory
2. Enter the name, number and some other information.
3. Press  and then press  button.

**Contact** **BlackList** [Hangup](#)

Index	Display Name	Office Number	Mobile Number	Other Number	Account
					All

**Save** **Delete** **Move to Contact/blacklist**

**Contact**

Name

Office Number

Mobile Number

Other Number

Account

Ring

Group

Photo

**Add** **Edit** **Search**

**GroupInfo**

Group

Ring

**Add** **Edit** **Delete** **Delete All**

  
**Delete Photo**

**Choose File** No file chosen

**Upload Photo**

**Import Local Contacts**

**Choose File** No file chosen

**Import XML** **Export XML**

**Choose File** No file chosen

**Import Csv** **Export Csv**  **Show Title**

**B: To add contacts into blacklist**

**To add blacklist manually via Phone interface:**

1. Press Menu→ Directory→ BlackList
2. Press Group soft key.
3. Press Add soft key.
4. Enter the Name and select the Ring Tone.
5. Press Save soft key or  to add the Group successfully.
6. Enter the added Group, then press Add soft key.
7. Enter the necessary information as Name, Phone number...
8. Press Save soft key or  to add the contacts successfully.

**To add blacklist from history via Phone interface:**

1. Press History soft key or press Menu→ History→ Local History→ All/ Missed/ Received/ Dialed/ Forwarded Calls
2. Press  and  to select the targeted one. (Press  and  switched among the All Calls, Missed Calls, Received Calls, Dialed Calls and Forwarded Calls).
3. Press Option soft key→ Add to Blacklist
4. Edit the necessary information as Name, Phone number...
5. Press Save soft key or  to add successfully.



**Upload Contacts photo via Web interface:**

1. Click Directory→ Directory and select the desired contact.
2. Click  to select the photo for the contact
3. Click  to upload the photo.

**Call Panel**

Dial Number

Account

**Contact** **BlackList**

Index	Display Name	Office Number	Mobile Number	Other Number	Account	<input type="checkbox"/>
1	amy	<a href="#">013</a>			Auto	Contacts <input type="checkbox"/>

**Contact**

Name

Office Number

Mobile Number

Other Number

Account

Ring

Group



未选择文件。

When you place a call from the contact, the phone idle screen will show the contact photo.

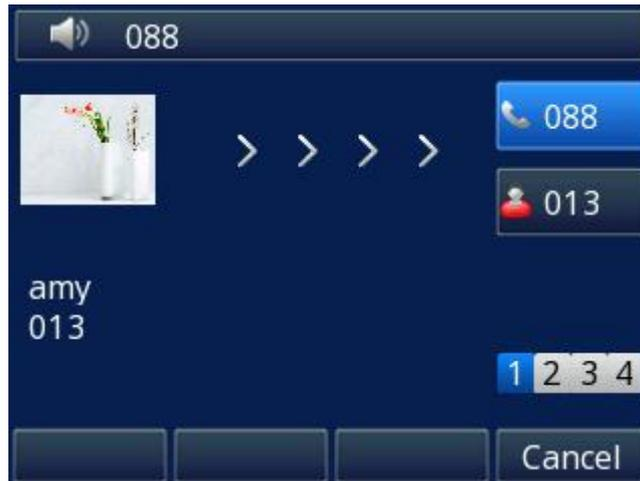

The contact photo server allows you to configure the contact's photo by modifying the xml file instead of uploading it on a web page.

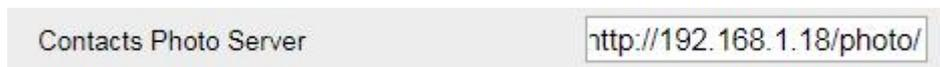

First, click Setting → Preference, and fill in the server path ( e.g.

http://192.168.1.18/photo/ ).

Then, fill in the file name in the quotes for the field photoDefault = "". ( e.g. photoDefault = "htek.jpg" ).

Finally, import the xml file to the phone.

```

<?xml version="1.0" encoding="UTF-8"?>
<contactData>
  <group>
    <contact sDisplayName="075" sOfficeNumber="075" sMobilNumber="" sOtherNumber="" sAccountIndex="255" sRing="Auto" group="" photoDefault="Config:gee.jpg" photoSelect="0" />
    <contact sDisplayName="076" sOfficeNumber="076" sMobilNumber="" sOtherNumber="" sAccountIndex="255" sRing="Auto" group="" photoDefault="Config:htek.jpg" photoSelect="0" />
  </group>
  <blacklist>
  </blacklist>
  <groupinfo>
  </groupinfo>
</contactData>
    
```

You can get the xml file through the export function.

**Note:**

1. The format of the photo supported is jpg or bmp
2. Photo size should be less than 2MB, name length should be less than 48 characters.

**To import or export the contact list**

You can manage your phone's local directory via phone or web user interface. But you can only import or export the contact list via Web interface.

**To import an XML file of contact list via Web interface:**

1. Click on Directory→ Directory
2. Click  to select a contact list file (file format must be .xml) from your local system.
3. Click  to import the contact list.

**To export an XML file of contact list via Web interface:**

1. Click on Directory→ Directory
2. Click  to export the contact list.

**To import a CSV file of contact list via Web interface:**

1. Click on Directory→ Directory
2. Click  to select a contact list file (file format must be .csv) from your local system.
3. Click  to import the contact list.

**To export a CSV file of contact list via Web interface:**

1. Click on Directory→ Directory
2. Click  to export the contact list.

**Note:**

If the XML file or CSV file has more than 1000 contacts, the phone will only upload 1000 contacts.

## Remote Phonebook

### To set Remote Phonebook via Web interface:

1. Login the webpage and click Directory→ Remote Phone Book
2. Fill the URL of the remote file in the Phone Book URL field. For example, `http://10.2.0.140/Phonebook/remotephonebook.xml`
3. Fill the Name and then click  to save the configuration.

Index	PhoneBook URL	Name
1	<input type="text" value="http://10.2.0.140/Phonebook/remotephoneboc"/>	<input type="text" value="test1"/>
2	<input type="text"/>	<input type="text"/>
3	<input type="text"/>	<input type="text"/>
4	<input type="text"/>	<input type="text"/>
5	<input type="text"/>	<input type="text"/>

Update Time Interval(minutes)  

### To check the contacts via Phone interface:

1. Press Directory→ Remote Contacts or Menu→ Directory→ Remote Contacts, and then you can see the item you set.
  2. Select the item and press Update.
  3. After updating completely, press Enter and you will find the detail.
- For More detail, please refer to: [Remote Phonebook](#).

#### Note:

Every remote phonebook, only supports 1000 contacts.

## LDAP Phonebook

When use the LDAP feature, you can get the LDAP Phonebook directly.

### To configure LDAP via Web interface:

1. Login webpage and click Directory→ LDAP
2. Fill the LDAP Name Filter:
  - a) This parameter specifies the name attributes for LDAP searching. The “%” symbol in the filter stands for the entering string used as the prefix of the filter condition.

b) For example, (cn=%), when the name prefix of the cn of the contact record matches the search criteria, the record will be displayed on the IP PHONE LCD.

3. Fill LDAP Number Filter: This parameter specifies the number attributes for LDAP searching.

4. Fill Server Address: Fill the domain name or IP address of the LDAP Server. For example: 192.168.0.253

5. Port (the port of the LDAP Server), Base, User Name, Password

6. Max.Hits(1-32000): the maximum number of the search results to be returned by the LDAP server.

7. LDAP Display Name: the display name of the contact record displayed on the LCD screen.

8. Filled the relative value and then click  to save the settings.

Following is the example screenshot for the configuration.

LDAP Name Filter	<input type="text" value="(cn=%)"/>	<a href="#">?</a>
LDAP Number Filter	<input type="text" value="( (telephoneNumber=%)"/>	<a href="#">?</a>
Server Address	<input type="text" value="192.168.0.253"/>	<a href="#">?</a>
Port	<input type="text" value="389"/>	<a href="#">?</a>
Base	<input type="text" value="ou=htek,dc=htek,dc=org"/>	<a href="#">?</a>
User Name	<input type="text" value="CN=ldapadmin,OU=Hte"/>	<a href="#">?</a>
Password	<input type="password" value="....."/>	<a href="#">?</a>
Max.Hits(1~32000)	<input type="text" value="32000"/>	<a href="#">?</a>
LDAP Name Attributes	<input type="text" value="sAMAccountName"/>	<a href="#">?</a>
LDAP Number Attributes	<input type="text" value="telephoneNumber"/>	<a href="#">?</a>
LDAP Display Name	<input type="text" value="sAMAccountName"/>	<a href="#">?</a>
Search Delay(0~2000ms)	<input type="text"/>	<a href="#">?</a>
Protocol	<input checked="" type="radio"/> Version2 <input type="radio"/> Version3	<a href="#">?</a>
LDAP Lookup For Call	<input type="radio"/> On <input checked="" type="radio"/> Off	<a href="#">?</a>
LDAP Sorting Results	<input type="radio"/> On <input checked="" type="radio"/> Off	<a href="#">?</a>
LDAP Synchronize Time(0~9999mins)	<input type="text"/>	<a href="#">?</a>

### To Configure LDAP Key

#### To configure LDAP Key via Web interface:

1. Click Function Keys→ Line Key→ choose Line Key2(for example)
2. Select LDAP in the Type field.
3. Click  to save the configuration.

Line	Type	Mode	Value	Label	Account	Extension
Key1	Line	Default		243	Account 1	
Key2	LDAP	Default			Account 1	

**To Configure LDAP Key via Phone interface:**

1. Press Menu→ Features→ Function Keys→ Line Keys as Function Keys→ Line Key2
2. Select LDAP in the Type field
3. Press Save or key to save the configuration.

When press the LDAP Key the LCD will display as following:



For More detail, please refer to [LDAP](#)

## Search Contact

You can search contact in all contacts, local contacts, remote contacts and LDAP contact.

**To search contact in All Contacts:**

1. Click the Directory soft key on Idle interface.
2. Select the All Contacts list and click Enter.
3. Click the More soft key, then you can see the Search soft key
4. Click the Search soft key, you can enter the desired part of name or part of number.
5. With the search content to match the contact will be automatically displayed on the LCD within 5 seconds.



**To search contact in Local Contacts:**

1. Click the Directory soft key on Idle interface.
2. Select the Local Contacts list and click Enter.
3. Click the More soft key, then you can see the Search soft key
4. Click the Search soft key, you can enter the desired part of name or part of number.
5. With the search content to match the contact will be automatically displayed on the LCD within 5 seconds.

**To search contact in Remote Contacts:**

1. Click the Directory soft key on Idle interface.
2. Select the Remote Contacts list and click Enter.
3. Select the desired remote phonebook and click Enter soft key.
4. Click the Search soft key, you can enter the desired part of name or part of number.
5. With the search content to match the contact will be automatically displayed on the LCD within 5 seconds.

**To search contact in LDAP contacts:**

1. Click the Directory soft key on Idle interface.
2. Select the LDAP list and click Enter.
3. Enter the first character or more of contact's name or number.
4. With the search content to match the contact will be automatically displayed on the LCD within 5 seconds.

## Call History Setting

### Call History

This phone maintains call history lists of Dialed Calls, Received Calls, Missed Calls and Forwarded Calls. The call history list supports up to 100 entries in all on phone interface and more than 1500 items. You can check the call history, dial a call, add a contact or delete an entry from the call history list. You should enable the history record feature in advance.

#### To enable the history record feature via Phone interface:

1. Press Menu→ Features→ History Setting
2. Press  and  or Switch soft key to enable History record.
3. Press Save soft key to save the configuration.



#### To check the call history via Phone interface:

1. Press the History soft key. The LCD screen displays All Calls list.
2. Press  or  to switch among All Calls, Missed Calls, Received Calls, Dialed Calls and Forwarded Calls.
3. Press  or  to select the desired entry.
4. Press the Option soft key, then select Detail from the prompt list and press the OK soft key.
5. The detailed information of the entry appears on the LCD screen.



**To Dial a call from Call History via Phone interface:**

1. Press the History soft key.
2. Press  or  to switch among All Calls, Missed Calls, Received Calls, Dialed Calls and Forwarded Calls.
3. Press  or  to select the desired entry.
4. Press the Dial soft key or .

**To delete an entry from the call history list via Phone interface:**

1. Press the History soft key.
2. Press  or  to switch among All Calls, Missed Calls, Received Calls, Dialed Calls and Forwarded Calls.
3. Press  or  to select the desired entry.
4. Press the Delete soft key.

**To delete all entries from the call history list via Phone interface:**

1. Press the History soft key.
2. Press  or  to switch among All Calls, Missed Calls, Received Calls, Dialed Calls and Forwarded Calls.
3. Press the Option soft key, and then select Delete All from the prompt list.
4. Press the OK soft key to confirm the deleting or the Cancel soft key to cancel.

**To check the call history via Web interface:**

1. Click Directory→ Call History
2. Click Dialed List, Missed List, Received List, or Forwarded List, then you can see the history list.

Dial List						
Missed List						
Received List						
Forwarded List						
Index	Date	Time	Local Identity	Name	Tel Number	
1	05-07-2019	05:26:21		amy	<a href="#">013</a>	▲
2	05-07-2019	04:39:40		004	<a href="#">004</a>	
3	03-04-2019	07:34:57		1105	<a href="#">1105</a>	
4	03-04-2019	07:33:43		1105	<a href="#">1105</a>	
5	03-04-2019	07:32:23		1105	<a href="#">1105</a>	
6	03-04-2019	07:31:09		1105	<a href="#">1105</a>	
7	03-04-2019	07:29:55		1105	<a href="#">1105</a>	
8	03-04-2019	07:28:41		1105	<a href="#">1105</a>	
9	03-04-2019	07:27:27		1105	<a href="#">1105</a>	
10	03-04-2019	07:26:13		1105	<a href="#">1105</a>	
11	03-04-2019	07:24:59		1105	<a href="#">1105</a>	
12	03-04-2019	07:23:45		1105	<a href="#">1105</a>	
13	03-04-2019	07:22:31		1105	<a href="#">1105</a>	
14	03-04-2019	07:21:17		1105	<a href="#">1105</a>	
15	03-04-2019	07:20:02		1105	<a href="#">1105</a>	
16	03-04-2019	07:18:48		1105	<a href="#">1105</a>	
17	03-04-2019	07:17:34		1105	<a href="#">1105</a>	
18	03-04-2019	07:16:09		1105	<a href="#">1105</a>	▼

Export XML    Export Csv

**To Dial a call from Call History via Web interface:**

1. Click Directory→ Call History
2. Select the desired history item, and click Tel Number.
3. Then the call is dialed on phone.

Dialed List		Missed List		Received List		Forwarded List	
Index	Date	Time	Local Identity	Name	Tel Number		
1	05-07-2019	05:26:21		amy	<a href="#">013</a>		
2	05-07-2019	04:39:40		004	<a href="#">004</a>		
3	03-04-2019	07:34:57		1105	<a href="#">1105</a>		
4	03-04-2019	07:33:43		1105	<a href="#">1105</a>		
5	03-04-2019	07:32:23		1105	<a href="#">1105</a>		
6	03-04-2019	07:31:09		1105	<a href="#">1105</a>		
7	03-04-2019	07:29:55		1105	<a href="#">1105</a>		
8	03-04-2019	07:28:41		1105	<a href="#">1105</a>		
9	03-04-2019	07:27:27		1105	<a href="#">1105</a>		
10	03-04-2019	07:26:13		1105	<a href="#">1105</a>		
11	03-04-2019	07:24:59		1105	<a href="#">1105</a>		
12	03-04-2019	07:23:45		1105	<a href="#">1105</a>		
13	03-04-2019	07:22:31		1105	<a href="#">1105</a>		
14	03-04-2019	07:21:17		1105	<a href="#">1105</a>		
15	03-04-2019	07:20:02		1105	<a href="#">1105</a>		
16	03-04-2019	07:18:48		1105	<a href="#">1105</a>		
17	03-04-2019	07:17:34		1105	<a href="#">1105</a>		
18	03-04-2019	07:16:09		1105	<a href="#">1105</a>		

Export XML    Export Csv

## Audio Setting

### Ring Tone

You can adjust the type and volume of the ring tone.

**To adjust the Ring Tone Type via Phone interface:**

1. Press Menu → Settings → Basic Setting → Ring Tone.
2. Press  and  to select the aimed one.
3. Press  or Save soft key to save the configuration.



#### To adjust the Ring Tone Type via Web interface

1. Setting→ Preference→ Ring Tones
2. Select the wanted one and enter the Ring Volume
3. Click  to save the configuration.

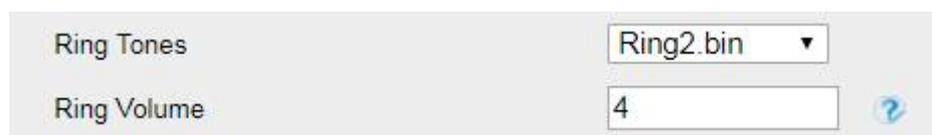

#### To configure Distinctive Ring Tone via Phone interface

1. Press Directory→ All Contacts/ Local Contacts/ LDAP
2. Select the target contact
3. Press Detail soft key to edit the contact.
4. Press and to select the wanted Ring Tone for the contact
5. Press Save soft key to save the contact.



#### To configure Distinctive Ring Tone via Web interface

1. Directory→ Directory→ Contact
2. Select the target contact

3. Choose the Ring Tone you want to use.

4. Click → to save the configuration.

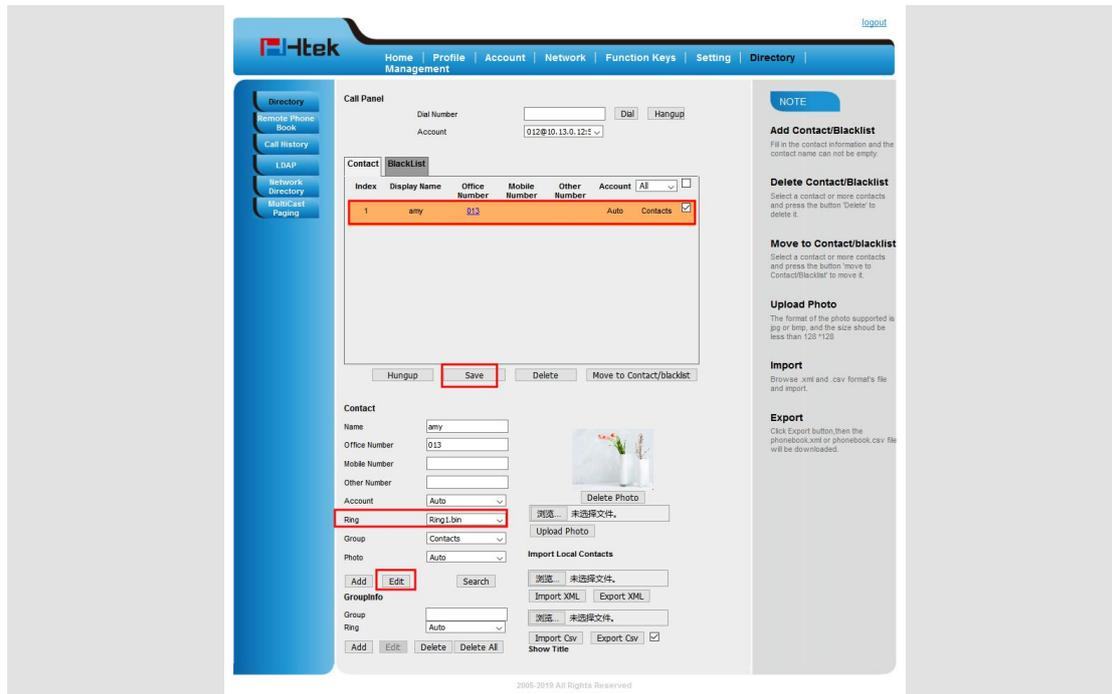

Click [Ring Tones](#) for more information.

## Volume

You can adjust the volume for the phone by the volume keys: and .

**To adjust the Ring tone volume via Phone interface:**

- Option 1: To press and on the idle page
- Option 2: To press and during the call is ringing.

**To adjust the handset volume via Phone interface:**

To press and during a call in handset mode.

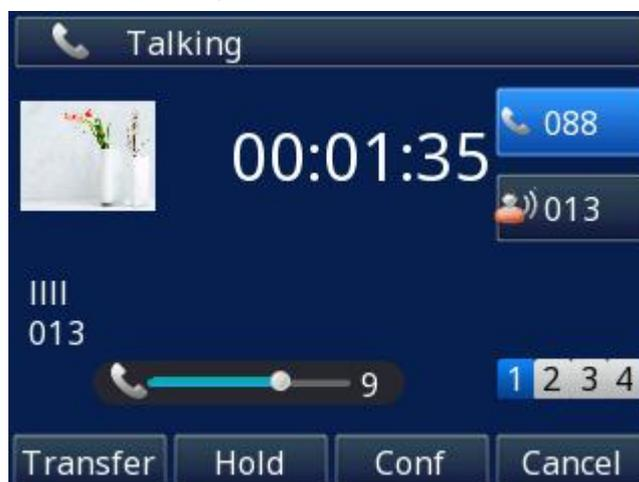

**To adjust the headset volume via Phone interface:**

To press and during a call in headset mode.

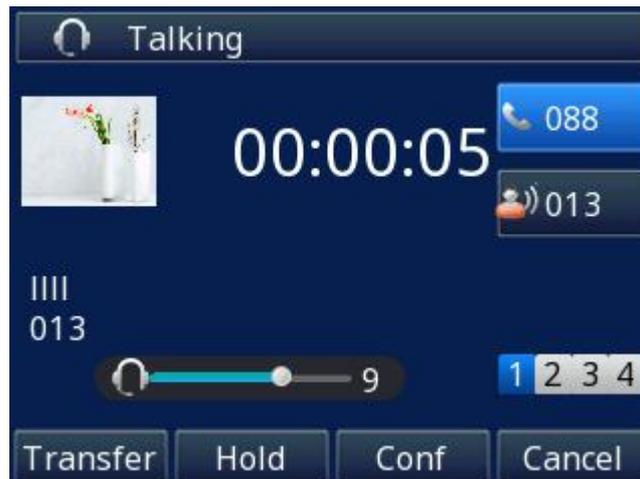

**To adjust the speaker Volume via Phone interface:**

To press and during a call in speaker mode.

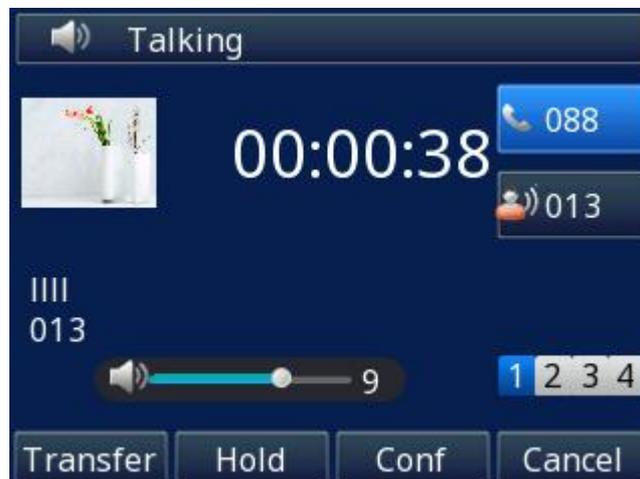

## Voice Mail Tone

This option can set whether to play the beep for phone's voice mail

1. Login webpage, and click the Setting→ Preference
2. Select On or Off for Voice Mail Tone.
3. Click for the setting.

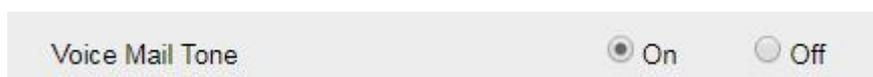

## Play Hold Tone

When you hold the phone, Whether to play hold tone

1. Login webpage, and click the Setting→ Preference
2. Set On or Off for Play Hold Tone.

3. Click  for the setting.

Play Hold Tone  On  Off

## Play Hold Tone Delay

When you hold the phone. How many seconds to play beep?

1. Login webpage, and click the Setting→ Preference
2. Set the value for Play Hold Tone Delay.

3. Click  for the setting.

Play Hold Tone Delay

## System Settings

### Dial Plan

Dial plan is a string of characters that governs the way this phone processes the inputs received from your phone keypad. This phone supports dial plan with following accept digits:

1,2,3,4,5,6,7,8,9,0, \*, #

Grammar	Description
x	any digit from 0-9;
xx+	at least 2-digit number;
^	exclude;
,	hear dial tone;
[3-5]	any digit of 3, 4, or 5;
[147]	any digit 1, 4, or 7;
<2=011>	replace digit 2 with 011 when dialing.

#### To configure dial plan via Web interface:

1. Click Account→ Basic.
2. Select the desired account from the pull-down list of Account in the Account field.
3. Fill the value in Dial Plan field.

4. Click  to save the configuration.

<b>Account</b>	Account 1 ▾
Account Status	243@192.168.0.8:15060 : Registered; UDP
* Account Active	<input type="radio"/> No <input checked="" type="radio"/> Yes
Profile	Profile 1 ▾
Label	<input type="text"/> ?
* SIP User ID	243 ?
* Authenticate ID	243 ?
* Authenticate Password	..... ?
Name	<input type="text"/> ?
Local SIP Port	5060 ?
Use Random Port	<input checked="" type="radio"/> No <input type="radio"/> Yes
Voice Mail UserID	<input type="text"/> ?
Dial Plan	{[x*]+}
Eventlist BLF URL	<input type="text"/>
Shared Line	Disable ▾
SCA Barge-In	Disable ▾ ?
Direct Call Pickup Code	**
Group Call Pickup Code	<input type="text"/>
Feature Key Sync	Disable ▾

**Note:**

Illegal input will fall back to default: {[x\*]+}. For More, please refer to [Dial Plan](#).

## Dial-Now Timeout

Dial-Now Timeout means that when you enter the number which is matching with dial plan,

it will dial out automatically after some time when you stop entering the number.

**To configure Dial-Now Timeout via Web interface:**

1. Click Setting→ Preference
2. Fill the blank of Dial-Now Timeout: for example, 5(seconds). (0 means dial out immediately).
3. Click the  button to save the configuration

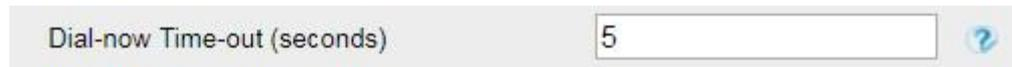

Dial-now Time-out (seconds)  

## No Key Entry Timeout

No Key Entry Timeout means that when you enter the number, it will dial out automatically after some time when you stop enter the number.

**To configure No Key Entry Timeout via Web interface:**

1. Click Setting→ Preference
2. Fill the blank of No Key Entry Timeout: for example, 5(seconds). (0 means never timeout, you should press the Dial key to dial out the number.)
3. Click the  button to save the configuration.

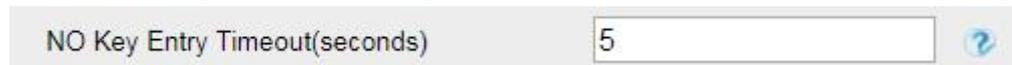

NO Key Entry Timeout(seconds)  

## Emergency Call

Public telephone networks in countries around the world have a single emergency telephone number (emergency services number), that allows a caller to contact local emergency services for assistance when required. The emergency telephone number may differ from country to country. It is typically a three-digit number that can be easily remembered and dialed quickly. Some countries have a different emergency number for each of the different emergency services.

You can specify the emergency telephone numbers on the IP phone for contacting the emergency services in an emergency situation.

**To configure emergency call via Web interface:**

1. Click Setting→ Features→ Phone Lock
2. Enter the emergency services number in the Emergency field,
3. Click  to save the configuration.

**Phone Lock**

Keypad Lock:

Phone Unlock Pin(0~15digital):

Auto Lock Time-Out(15~3600s):

Emergency:

## Lable Scroll

When setting function keys, you need to set the label of the function keys. If the words are too long to show on the label, you can use this function to make labels scroll. Another approach is to set the labels to Long Label mode.

**To configure Label Scroll via Web interface:**

1. Click Setting→ Preference
2. Select Enable or Disable for Lable Scroll.
3. Click  for the setting.

Lable Scroll

## Show Missed Calls

Whether to show missed call notification on LCD

**To configure Show Missed Calls via Web interface:**

1. Click Setting→ Preference
2. Select Yes or No for Show Missed Calls.
3. Click  for the setting.

Show Missed Calls  Yes  No

## Auto Logout Time

Set the Web login timeout

1. Login webpage, and click Setting→ Preference
2. Set number 1~5000 min for Auto Logout Time.
3. Click  for the setting.

Auto Logout Time (1 ~ 5000 min)

## Reboot in Talking

This function is to allow reboot during the calls or not

1. Login webpage, and click Setting→ Preference
2. Set Enable or Disable for Reboot in Talking.
3. Click  for the setting.

Reboot in Talking	<input type="button" value="Disable"/>
-------------------	--

## Detect IP Conflict

LCD can display message when IP conflict

1. Login webpage, and click Setting→ Preference
2. Set Enable or Disable for Detect IP Conflict.
3. Click  for the setting.

Detect IP Conflict	<input type="button" value="Enable"/>
--------------------	---------------------------------------

## Redial Mode

Call redial has two ways:(1) To redial the last placed call from the IP Phone (2) To redial the call from all calls list

1. Login webpage, and click Setting→ Preference
2. Set Direct Mode or Select Mode for Redial Mode.
3. Click  for the setting.

Redial Mode	<input checked="" type="radio"/> Direct Mode
	<input type="radio"/> Select Mode

## Keypad Lock

**To enable Keypad Lock via Phone interface:**

1. Press Menu→ Settings→ Advanced Setting→ Phone Setting→ Lock
2. Press ,  key or Switch soft key to change selected lock type: All keys, Menu Key, Function Key, Lock & Answer
3. Press Save or  key to save the configuration.

**To disable Keypad Lock via Phone interface:**

1. Press Menu→ Settings→ Advanced Setting→ Phone Setting→ Lock

2. Press  and  key or Switch to change to choose Disable.
3. Press Save or  key to save the configuration.

**To enable Keypad Lock via Web interface:**

1. Click Setting→ Features→ Phone Lock
2. To choose All Keys, Menu Key, or Function Keys for the Keypad Lock.
3. Fill the Phone Unlock Pin and Auto Lock Time-Out.
4. Fill the Emergency number. When the phone is Lock, only Emergency number can be sent.
5. Click  to save the configuration.



**To Disable Keypad Lock via Web interface:**

1. Click Setting→ Features→ Phone Lock
2. Choose Disable for the Keypad Lock.
3. Click  to save the configuration.

## Suppress DTMF Display

In order to ensure safety in Call process, you can choose whether to hide DTMF

1. Login webpage, and click Setting→ Preference
2. Select On or Off for Suppress DTMF Display.
3. Click  for the setting.

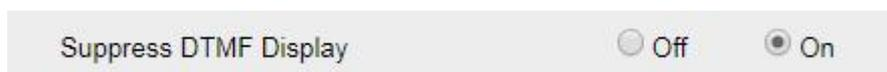

## Suppress DTMF Display Delay

In order to ensure safety in Call process, you can choose whether to hide DTMF

1. Login webpage, and click Setting→ Preference
2. Select On or Off for Suppress DTMF Display Delay.
3. Click  for the setting.

Suppress DTMF Display Delay

 Off On

## Check-Syn With Authenticate

If this option is enabled, the server needs to be authenticated before the phone agrees to synchronize.

1. Login webpage, and click Setting→ Preference
2. Set Enable or Disable for Check-Syn With Authenticate.
3. Click  for the setting.

Check-Syn With Authenticate

Disable ▼



## Other features settings

### Action URL

**To configure action URL via Web interface:**

1. Click Setting→ Action URL
2. Fill the needed values in the designated blank spaces.
3. Click  to save the setting.

Click [Action URL](#) for more about how to use, or check on [www.htek.com](http://www.htek.com)

Setup Completed	<input type="text"/>	<a href="#">?</a>
Log On	<input type="text"/>	<a href="#">?</a>
Log Off	<input type="text"/>	<a href="#">?</a>
Register Failed	<input type="text"/>	<a href="#">?</a>
Off Hook	<input type="text"/>	<a href="#">?</a>
On Hook	<input type="text"/>	<a href="#">?</a>
Incoming Call	<input type="text"/>	<a href="#">?</a>
Outgoing Call	<input type="text"/>	<a href="#">?</a>
Call Established	<input type="text"/>	<a href="#">?</a>
Call Terminated	<input type="text"/>	<a href="#">?</a>
Open DND	<input type="text"/>	<a href="#">?</a>
Close DND	<input type="text"/>	<a href="#">?</a>
Open Always Forward	<input type="text"/>	<a href="#">?</a>
Close Always Forward	<input type="text"/>	<a href="#">?</a>
Open Busy Forward	<input type="text"/>	<a href="#">?</a>
Close Busy Forward	<input type="text"/>	<a href="#">?</a>
Open No Busy Forward	<input type="text"/>	<a href="#">?</a>
Close No Busy Forward	<input type="text"/>	<a href="#">?</a>
Transfer Call	<input type="text"/>	<a href="#">?</a>
Blind Transfer call	<input type="text"/>	<a href="#">?</a>
Attended Transfer Call	<input type="text"/>	<a href="#">?</a>
Hold	<input type="text"/>	<a href="#">?</a>
Unhold	<input type="text"/>	<a href="#">?</a>
Mute	<input type="text"/>	<a href="#">?</a>
Unmute	<input type="text"/>	<a href="#">?</a>
Missed Call	<input type="text"/>	<a href="#">?</a>
Idle To Busy	<input type="text"/>	<a href="#">?</a>
Busy To Idle	<input type="text"/>	<a href="#">?</a>
Forward Incoming Call	<input type="text"/>	<a href="#">?</a>
Reject Incoming Call	<input type="text"/>	<a href="#">?</a>
Answer New Incoming Call	<input type="text"/>	<a href="#">?</a>
Transfer Finished	<input type="text"/>	<a href="#">?</a>
Transfer Failed	<input type="text"/>	<a href="#">?</a>

## Softkey Layout

This feature mainly defines which shown on the soft key in some status. For example, what the soft key displays when dialing, or talking.

**To configure Soft key via Web interface:**

1. Click Setting→ Softkey Layout
2. Select Enable for Custom Softkey
3. Select Call States.
4. Select the feature from the Disable Keys to Enable Keys field by .  moves the Disable key to Enable field.  moves the Enable key, and it will back to Disable field.
5. Click  or  to change to position for each feature.
6. Click  to save the configuration.

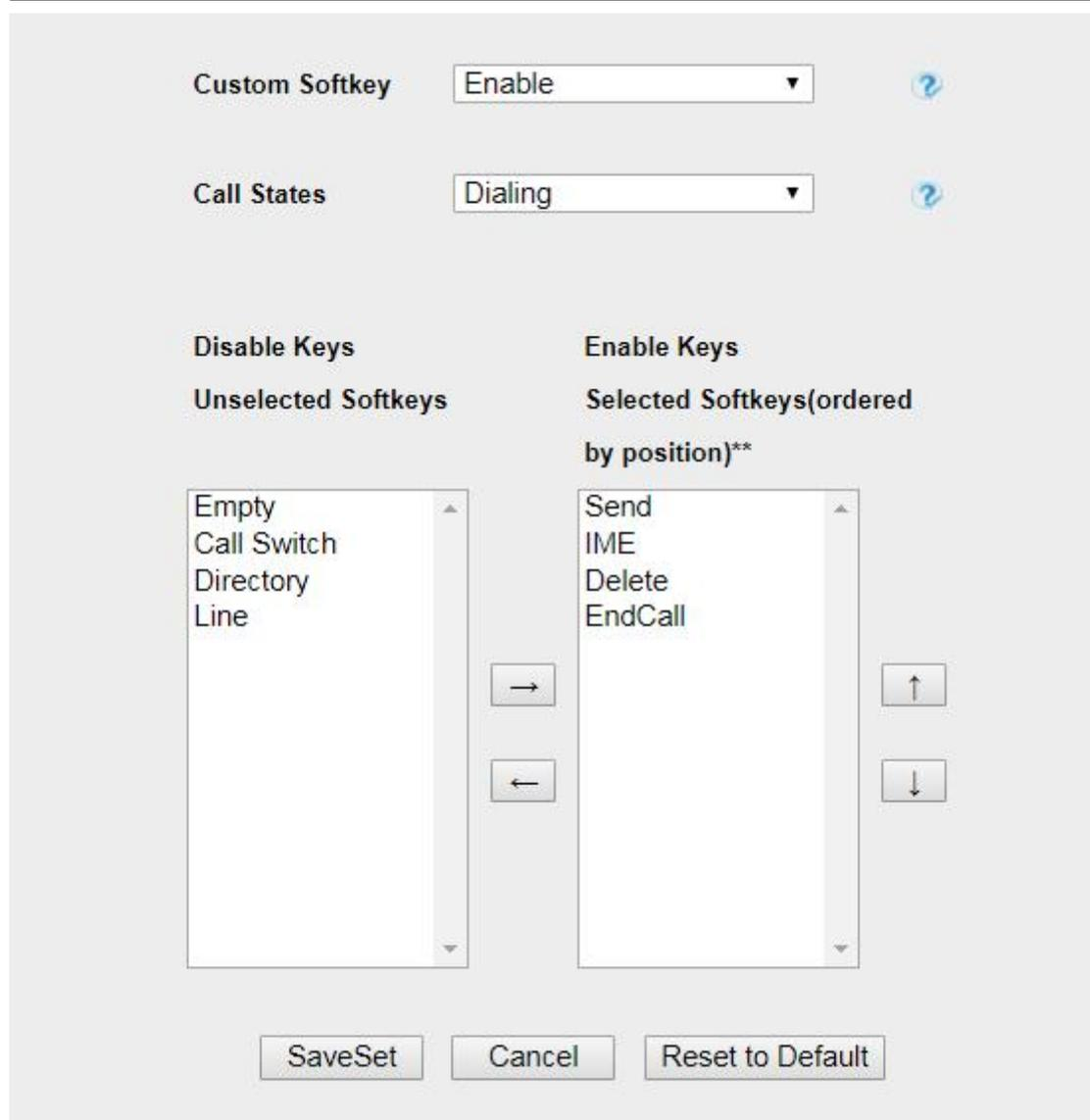
**Note:**

When there are more than 5 items in the Enable field, the last soft key will display More, and last two item will show on the next page of soft key, you can check by press More.

## Programmable Key

For the default keys as Soft Keys, Navigation Keys and so on, you can define them as some specific feature, and it works only on the idle page.

**To configure Programmable Key via Web interface:**

1. Click Function Keys→ Programmable Key.
2. Select the desired Key to set.
3. Click  to save the setting.
4. By clicking , all setting of the keys will be back to default.

Key	Type	Label	Account	Value
SoftKey1	History ▾		Account 1 ▾	
SoftKey2	Directory ▾		Menu View ▾	
SoftKey3	DND ▾		Account 1 ▾	
SoftKey4	Menu ▾		Account 1 ▾	

Key	Type	Account	Value
Up	History ▾	Account 1 ▾	
Down	Directory ▾		
Left	Switch Account Up ▾	Account 1 ▾	
Right	Switch Account Down ▾	Account 1 ▾	
OK	Status ▾	Account 1 ▾	
Cancel	N/A ▾	Account 1 ▾	
MUTE	N/A ▾	Account 1 ▾	
CONF	N/A ▾	Account 1 ▾	
TRAN	Forward ▾	Account 1 ▾	
HOLD	N/A ▾	Account 1 ▾	
Speaker	Speaker ▾	Account 1 ▾	
Headset	Headset ▾	Account 1 ▾	
VM	VM ▾	Account 1 ▾	
Volume Up	Volume Up ▾	Account 1 ▾	
Volume Down	Volume Down ▾	Account 1 ▾	

## Basic Call Features

### Place a Call

There are three ways to dialing a call: Handset, Headset and Hands-free loud speaker.

#### To place a call by Handset:

1. Pick up the handset and enter the necessary number.
2. Press  or  or press the Send soft key, then the call is sending.

#### To place a call by Headset:

1. Press the  (light is Green),
2. Enter the desired number.
3. Press  or , or press the Send soft key, then the call is sending.

#### Using headset to place and answer calls for all time:

1. Login webpage, and click Setting→ Preference
2. HeadSet Priority→ Enable
3. Ring Device For HeadSet→ User HeadSet
4. Click  to save the setting.
5. Press .

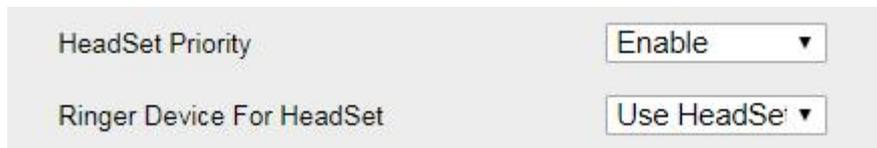

#### To place a call by hands-free speakerphone:

1. Press the , or press the Line key, then you can hear the dial tone.
2. Press the number.
3. Press  or  or press the Send soft key, then the call is sending.

#### To place a call by call history or Directory via Phone interface:

1. Press the History / Directory→ All Contacts/ Local Contacts/ LDAP (On the idle page) or Menu→ History / Directory→ All Contacts/ Local Contacts/ LDAP
2. Press  and  to select the targeted one.
3. Press the Send soft key, or , or , or the corresponding line key, then the call is sending.

#### Note:

1. The  key is set to be a Send key. For more information, refer to the [Key as](#)

[Send](#) on page

2. During the call, you can also change among Headset, Handset or Free-speaker mode.

#### **Making two calls with one line and one account**

1. Press a line key and dial the phone number, then make a call.
2. Press Hold soft key and then press New Call soft key.
3. Dial another phone number,
4. Press the Send soft key, or , then make the second call.

## End a Call

Here shows to end a call during three modes:

#### **To end a call by Handset**

Press the End Call soft key or hang up the handset.

#### **To end a call under Headset Mode**

Press the End Call soft key or press .

#### **To end a call under Hands-free speakerphone Mode**

Press the End Call soft key or press .

#### **Note:**

During the conference, to end the call is same as mentioned above.

## Redial a Call

#### **To redial the last placed call from the IP Phone:**

Press  directly when LCD is on the idle interface.

## Receive a Call

There are three ways to receive a call when the phone is ringing:

#### **To receive a call by handset**

Pick up the handset and now the conversation is built.

#### **To receive a call by headset**

Press  and now the conversation is built.

#### **To receive a call by hands-free speakerphone**

1. Option 1: Press  directly.
2. Option 2: Press Answer soft key.
3. Option 3: Press the Line key (flashes red).

Moreover, some other action can be done by soft key when the call is coming.

1. Press the Reject soft key to reject the call.
2. Press Forward soft key to forward to another phone.
3. Press Silence soft key, and then the call will keep silent, no ring tone display.

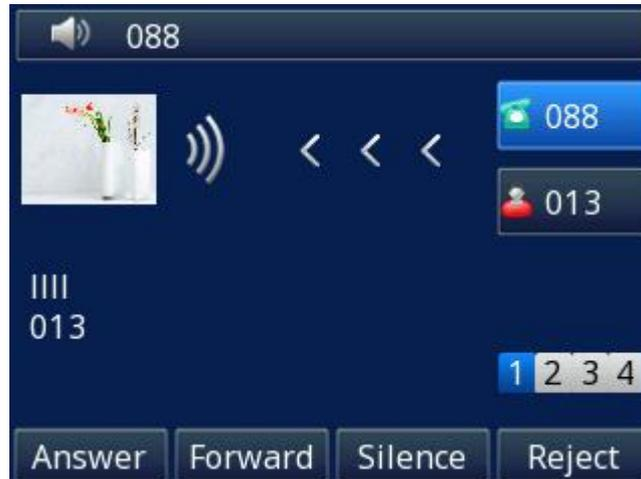

## Incoming Call Show Mode

There are two incoming call show modes for this phone:

1. name of the contacts
2. name and number of the contacts
3. name and number of the incoming call and the account which is connecting

**To set Incoming Call Show Mode via Web interface:**

1. Click Setting→ Preference
2. Select the desire mode for the Incoming Call Show Mode
3. Click  to save the setting.



## Auto Answer

Enable Auto Answer feature, you will answer all incoming call automatically.

**To enable Auto Answer via Web interface:**

1. Click Profile→ Advanced
2. Select the desired profile from the pull-down list of Profile in the Profile field.
3. Choose Yes for the Auto Answer.
4. Click  to save the configuration.

Auto Answer	<input type="radio"/> No	<input checked="" type="radio"/> Yes
Allow Auto Answer By Call-Info	<input type="radio"/> No	<input checked="" type="radio"/> Yes

**To disable Auto Answer via Web interface:**

1. Click Profile→ Advanced
2. Select the desired profile from the pull-down list of Profile in the Profile field.
3. Choose No for the Auto Answer.
4. Click  to save the configuration.

## Call Hold

When using the Hold feature, the Hold icon will show on the display.



To make a call on hold during three modes:

**To hold a call under handset mode:**

1. Press Hold soft key to hold the current call.
2. Press Resume soft key to resume the call on hold.

**To hold a call under headset mode:**

1. Press Hold soft key to hold the current call.
2. Press Resume soft key to resume the call on hold.

**To hold a call during the speaker mode:**

1. Press Hold soft key to hold the current call.
2. Press Resume soft key to resume the call on hold.

## Call Transfer

This phone supports Blind, Attended and Semi-Attended Transfer.

**Blind Transfer**

When you use this feature, you can

1. Press  or Transfer soft key during the conversation, the call is on hold now.

2. Enter the number that transfers to.
3. Press  or Transfer soft key, and now the blind transfer is completed.

### Attended Transfer

When you use this feature, you can

1. Press  or Transfer soft key during the conversation, the call is on hold now.



2. Enter the number that transfers to, and press the Send soft key or  or .
3. Start the second conversation, then press  or Transfer soft key, and now transfer is completed.

### NOTE:

**To transfer calls across SIP domains, SIP service providers must support transfer across SIP domains. Blind transfer will usually use the primary account SIP profile.**

### Semi-Attended Transfer

1. Press  or Transfer soft key during the conversation, the call is on hold now.
2. Enter the number transfer to, and then press the Send soft key or  or , then you can hear the ring tone.
3. Press  or the Transfer soft key, and now the Semi-attended transfer is completed.

### BLF Transfer

1. Set a Programmable Key or Line Key as BLF. For how to set BLF, please refer to [BLF](#)
2. Configure the Transfer Mode via DSSkey.
3. Press BLF key during the conversation then realize Blind, Attended and Semi-Attended Transfer.

**Transfer Settings**

Blind Transfer On Hook  On  Off

Semi-Attended Transfer  On  Off

Attended Transfer On Hook  On  Off

Transfer Mode via DSSkey Attended Transfer ▼

Hold Transfer On Hook  On  Off

#### Hold Transfer On Hook:

1. Login webpage, and click Setting→ Features→ Transfer Settings: Hold Transfer On Hook: On.
2. A enables the Hold Transfer On Hook feature.
3. During the conversation with B, A presses the Hold soft key and places a new call to C.
4. A cancels the call after C answers.
5. Then C and B are in the same call and the transfer is successful.

**Transfer Settings**

Blind Transfer On Hook  On  Off

Semi-Attended Transfer  On  Off

Attended Transfer On Hook  On  Off

Transfer Mode via DSSkey Attended Transfer ▼

Hold Transfer On Hook  On  Off

#### Hold transfer on Three Way conference:

1. Login webpage, and click Setting→ Preference→ Three Way Call Release Type: Transfer.
2. When acting as the initiator of the three-way conference, the IP Phone presses the End Call soft key or on-hook to exit the conference in the process of talking.
4. Then the other two IP Phones will continue to talk.

Three Way Call Release Type Transfer ▼

#### Transfer to New Call via Web interface

1. Click Setting→ Features
2. Select Transfer Mode via DSSkey: New Call
3. Click Function Keys→ Line Key
4. Select the desired Line Key and select BLF in the Type.
5. Enter the phone number in the Value field.

**Transfer Settings**

Blind Transfer On Hook  On  Off

Semi-Attended Transfer  On  Off

Attended Transfer On Hook  On  Off

Transfer Mode via DSSkey  ▼

Hold Transfer On Hook  On  Off

Line	Type	Mode	Value	Label	Account	Extension
Key1	Line ▼	Default ▼		243	Account 1 ▼	
Key2	BLF ▼	Default ▼	245		Account 1 ▼	

**NOTE:**  
 If the person that wanted to be spoken to do not want to answer the call, then the person that answered the coming call could use this function.

**Transfer Release Trigger**

This option defines when the phone sends BYE to the server to release the transferred call. Login webpage, and click Profile→ Basic→ Transfer Release Trigger:

**1. NOTIFY with 200OK**

After receiving REFER request sended by the phone, server will send NOTIFY to the phone, and the phone response 200OK, this is the trigger for the phone to release the call.

**2. 2xx response of REFER**

The phone will not release the call until it receives a 2xx response from the server to the phone's REFER request.

**3. BYE for the call**

The phone will not release the call until receiving BYE from the server.

Transfer Release Trigger:  ▼

## Call Conference

This IP Phone supports up to 5-way conference.

**5-way conference**

1. Assuming that call party **A** and **B** are in conversation. **A** wants to bring **C**, **D** and **E** in a conference
2. **A** press the Conf soft key, the call is placed on hold.
3. **A** enter the number of **C** and then press Send soft key or .
4. **C** answer the call.
5. **A** press the Conf soft key, then **A**, **B** and **C** are now in a conference. (and now this is

**3-way conference)**

6. **A** press the Conf soft key, the current 3-way conference is placed on hold.

7. **A** enter the number of **D** and then press Send soft key or .

8. **D** answer the call.

9. **A** press the Conf soft key, then **A, B, C** and **D** are now in a conference. (and now this is **4-way conference)**

10. **A** press the Conf soft key, the current 4-way conference is placed on hold.

11. **A** enter the number of **E** and then press Send soft key or .

12. **E** answer the call.

13. **A** press the Conf soft key, then **A, B, C, D** and **E** are now in a conference. (and now this is **5-way conference)**

14. **A** end the call, the conference is finished.

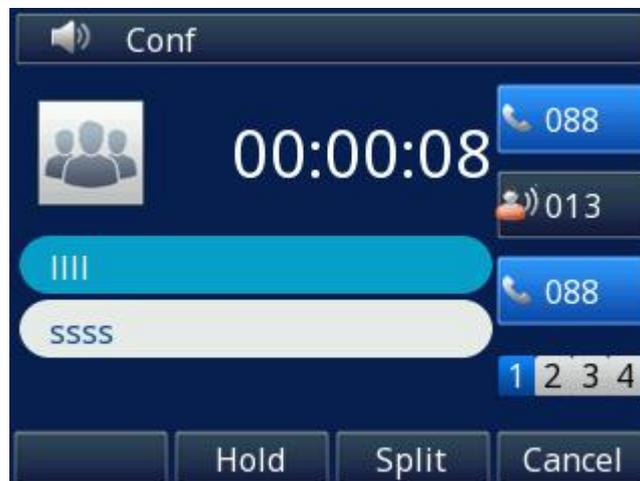

**Note:**

1. If **C** does not answer the call, **A** can back to continue the conversation with **B**;
2. Once **A** hangs up the call, the conference is ended, while if **B** or **C** drops the call, **A&C** or **A&B** continues the conversation.
3. The conference feature is not available on all servers. For more information, contact your system administrator.
4. To realize the 5-way conference, the line should be all available.

## Call Forward

This phone supports static forward (always forward, busy forward and no answer forward) and dynamic forward

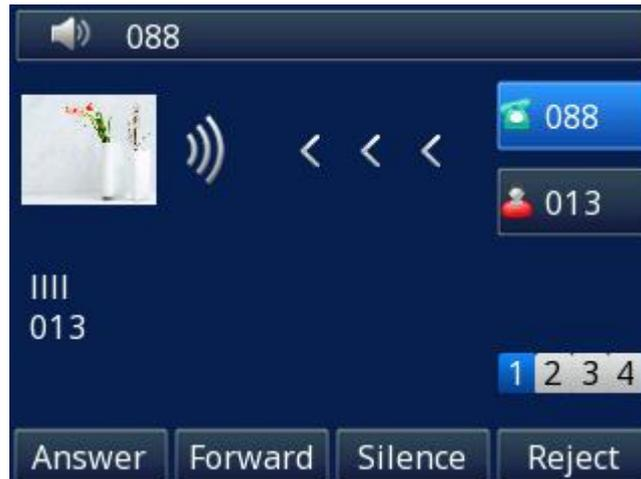

#### To configure static forward

##### To configure always forward via Phone interface:

With this feature, all incoming calls will forward immediately to configured number.

1. Press Menu→ Features→ Call Forward→ Always Forward.

2. Press  and  to select the Enable choice

3. Enter the Forward To number.

4. Enter the On Code and Off Code (optional).

5. Press  or Save soft key to save the configuration.



##### To configure busy forward via Phone interface:

With this feature, the incoming calls are immediately forwarded if the phone is busy.

1. Press Menu→ Features→ Call Forward→ Busy Forward.

2. Press  and  to select the Enable choice.

3. Enter the Forward To number.

4. Enter the On Code and Off Code (optional).

5. Press  or Save soft key to save the configuration.

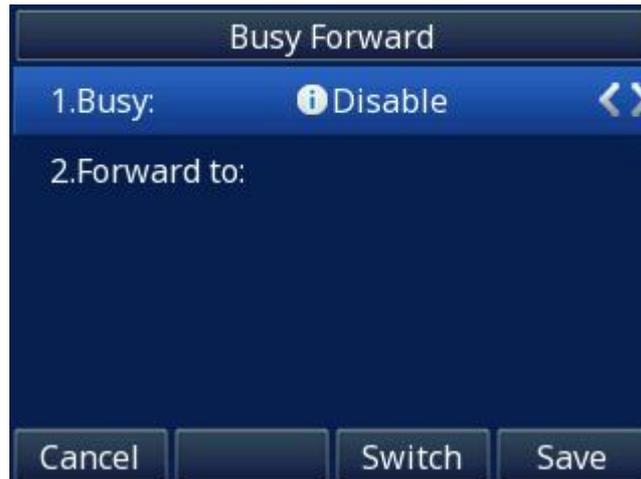

**To configure no answer forward via Phone interface:**

No Answer Forward: Incoming calls are forwarded if not answered after some time.

1. Press Menu→ Features→ Call Forward→ No Answer Forward.

2. Press  and  to select the Enable choice

3. Enter the Forward To number and After Ring Times.

4. Enter the On Code and Off Code (optional).

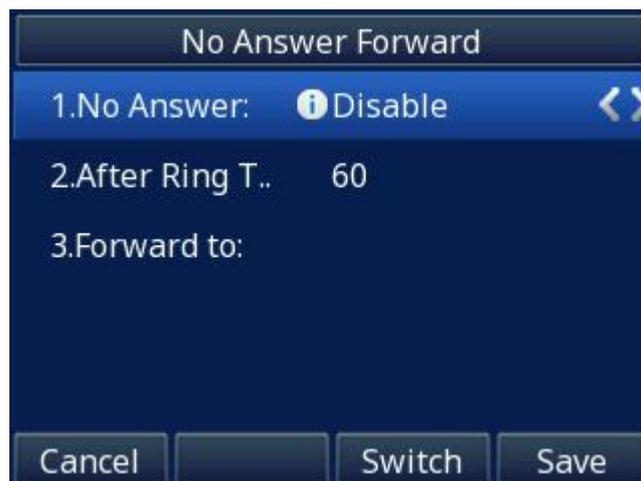

5. Press  or Save soft key to save the configuration.

When the Forward feature is enabled, the Icon  will display on Top of the LCD.

**To configure Forward via Web interface**

1. Setting→ Features
2. Click On for the Always/Busy/No Answer
3. Fill the Target number
4. Fill the After Ring Time
5. Fill the On Code and Off Code (optional).
6. Click  to save the configuration

[-] Forward: ?

**Always**
 On  Off

Target

?

On Code

?

Off Code

?

**Busy**
 On  Off

Target

?

On Code

?

Off Code

?

**No Answer**
 On  Off

After Ring Time(seconds)

?

Target

?

On Code

?

Off Code

?

**Selective**
 On  Off

Target

?

Entry

?

#### To cancel the forward feature via Phone interface

1. Option 1: To press the  key to disable the forward feature.
2. Option 2: Press Menu → Features → Call Forward → Always/Busy/No Answer Forward
  - a. Press  and  to select the Disable choice
  - b. Press  or Save soft key to save the configuration.

#### To cancel the forward feature via Web interface

1. Setting → Features
2. Click Off for the Always/Busy/No Answer
3. Click  to save the configuration

#### To configure dynamic forward

**Forward an incoming call during the ringing.**

97

1. When the phone is ringing, press Forward soft key.
2. Enter the forward number or select the desired number from Directory soft key (Precondition: local directory has one or more contacts).
3. Press  or press the Send soft key, then the call is forwarded.

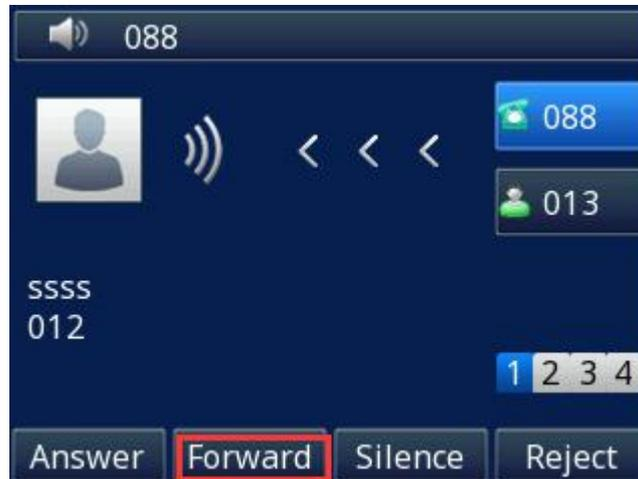

**Note:**

1. If the Programmable Key or line key is set as BLF, when an incoming call ringing, press this BLF key directly to realize the dynamic forward.
2. You can choose a desired forward number from the Directory when you press the Forward key.

## Call Return

This feature allows you to dial the last phone call you received.

**To configure the Call Return via Phone interface**

1. Press Menu → Features → Function Keys → Line Keys as Function Keys → Line Key2(for example)
2. Press  and  key to select the Call Return in the Type field.
3. Press  or Save soft key to save the configuration

**To configure the Call Return via Web interface**

1. Click Function Keys → Line Key.
2. Select the desired Line Key and select Call Return in the Type field.
3. Click  to save the configuration.

Line	Type	Mode	Value	Label	Account	Extension
Key1	Line	Default		243	Account 1	
Key2	Call Return	Default			Account 1	

## Call Back

When this option is set, if the phone you call is busy and does not set call waiting or voice mail, your LCD screen will prompt for call-back, as shown in figure

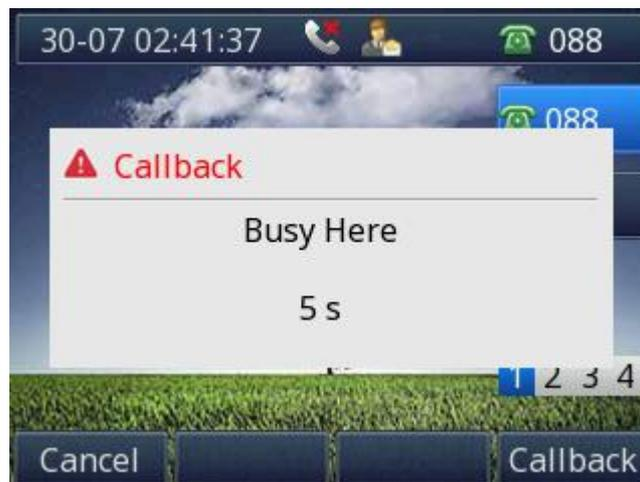

If you press the Callback, the phone will dial the Callback phone number.

### To configure the Call Back via Web interface

1. Click Setting→ Features→ Callback .
2. Fill the Callback phone number in the Callback Code field.
3. Click  to save the configuration.

Callback

Callback Code

## Call Waiting Tone

### To enable the Call Waiting and Call Waiting Tone via Web interface

1. Click Setting→ Features
2. Select Call Waiting: On and Call Waiting Tone: On

**Call Waiting**

Call Waiting  On  Off

Call Waiting Tone  On  Off

### To Change the Call Waiting Tone time via Web interface

1. Click Setting→ Tones

Select Country

Dial Tone

Ringback Tone

Busy Tone

Reorder Tone

Confirmation Tone

Call Waiting Tone

**Syntax:** f1=freq@vol, f2=freq@vol, c=on1/off1-on2/off2-on3/off3; [...]

**Note:** freq: 0 - 4000Hz; vol: -30 - 0dBm

2. Change the Tone Time as you want (for example 3s)

Call Waiting Tone

## Hide Caller ID

Just enable the unknown/hidden caller feature, by enabling Anonymous call feature thereby the receiver won't be able to know who is calling them.

### To configure anonymous call via Phone interface

1. Press Menu→ Features→ Anonymous Call→ Account ID 1/ 2

2. Press  and  to select the Enable choice in Anonymous Call filed.

3. Enter the Call On Code (optional), Call Off Code (optional).

4. Press  or Save soft key to save the configuration.

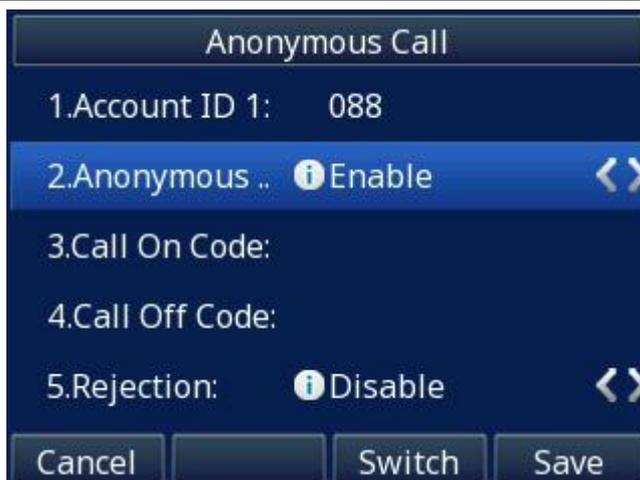

#### To cancel anonymous call feature via Phone interface

1. Press Menu→ Features→ Anonymous Call→ Account ID 1/ 2
2. Press  and  key to select the Disable choice in Anonymous Call filed.
3. Press  or Save soft key to save the configuration.

## Reject Anonymous

If you do not want to be disturb by anonymous calls, you can set the reject anonymous call feature, so you will not hear the unknown calls

#### To configure rejecting anonymous call

1. Press Menu→ Features→ Anonymous Call→ Account ID 1/ 2
2. Press  and  key to select the Enable choice in Rejection filed.
3. Enter the Reject On Code (optional), Reject Off Code (optional).
4. Press  or Save soft key to save the configuration

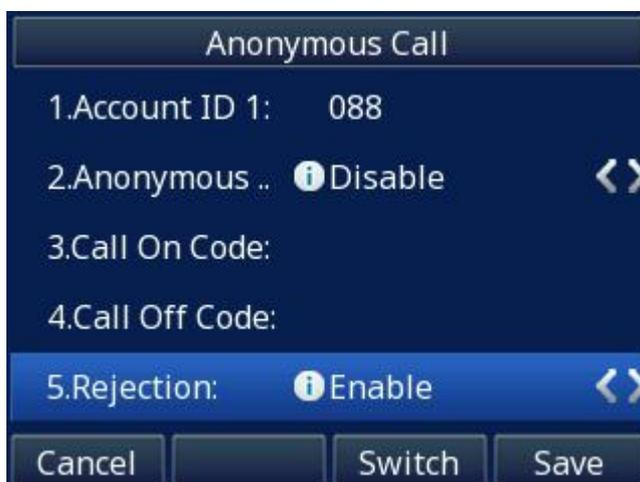

#### To cancel rejecting anonymous call

1. Press Menu→ Features→ Anonymous Call→ Account ID 1/ 2

2. Press  and  key to select the Disable choice in Rejection filed.
3. Press  or Save soft key to save the configuration.

## Call Mute

When you use the Mute feature, the other parties will not hear your voice while you can hear their voice. Call mute applies to all modes (handset, headset, and speakerphone).

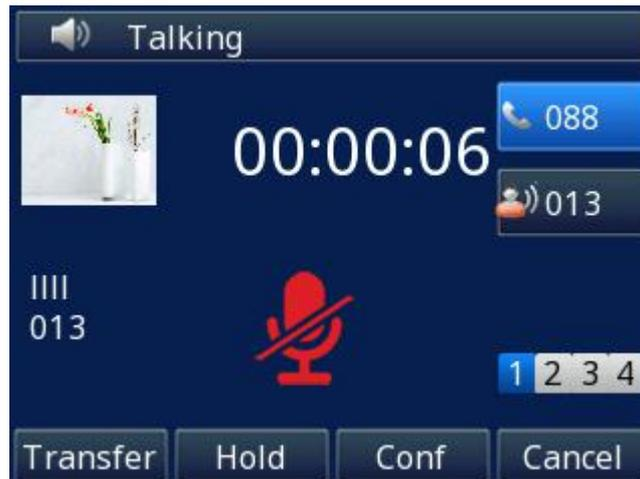

**To mute the call during a call (including a conference call)**

1. Press the mute key , then the mute key glows green, and the LCD display 
2. To disable the mute function, press  again.

## DND

When you use the DND feature, the phone is to reject all incoming calls automatically and you can see the DND icon  shown on the Top of the LCD on idle page.



#### To enable DND feature via Phone interface:

Press the DND soft key when the phone is idle, and then  is shown on the LCD.

#### To disable DND feature via Phone interface:

Press the DND soft key again, and then there is no  on the LCD.

## Hot Line

#### To configure Hot Line via Phone interface

1. Press Menu→ Features→ Hot Line
2. Enter the Number and HotLine Delay time (as present, we support off hook auto dial).
3. Press  or Save soft key to save the configuration



#### To configure Hotline auto dial via Web interface

1. Setting→ Features.
2. Fill the number in the Hotline Number and Hotline Time-out field.
3. Click  to save the configuration.

**HotLine**

Hotline Number

Hotline Time-out(seconds)(0~180s)

4. Delete the Hotline Number and save the configuration, then now the Hotline auto dial is cancelled.

## Auto Redial

When this option is set, if the phone you call is busy and does not set call waiting or voice mail, your LCD screen will prompt for Auto Redial, as shown in figure.



If you press OK, your LCD will prompt Auto Redial Interval and Auto Redial Times

### To configure Auto Redial via Web interface

1. Click Setting→ Features→ Auto Redial
2. Select On or Off for the Auto Redial.
3. Fill the number 1~300 seconds for the Auto Redial Interval.
4. Fill the number 1~300 times for the Auto Redial Times.
5. Click  to save the configuration.

**Auto Redial**

Auto Redial  On  Off

Auto Redial Interval (1~300s)

Auto Redial Times (1~300)

## Function Key Features and Settings

The function key supports the **Line Label Length**, **Line Page Indicator**, **BLF list MODE**, **line key as cancel**, **BLF blink**.

**Line Label Length:** If this option is set Long label, then the label's length will be longer, it is used if the string is too long.

**Line Page Indicator:** Enable this option when the phone has been configured for multiple pages. For example, when current page is the first page, the second page has a BLF and BLF's status is changed, the second page's button will flash the red indicator.

UC921(G) has 12 Function Keys.

**BLF blink:** Turn this option on to make the BLF key blink when the monitored extension is ringing or talking.

## Line

It works same as Line keys.

Line support three Mode (Default, Lock and Float)

**Default mode:** If there is an incoming call, the phone won't navigate to the set line key's page if the line key is set as Line type and current page is not the set line key's page.

**Lock mode:** The line key will reflect on the same position on every page when the line key is set as the Line type.

**Float mode:** If there is an incoming call, the phone will navigate to the set line key's page if the line key is set as Line type and current page is not the set line key's page.

### To configure Line feature via Phone interface

1. Press Menu→ Features→ Function Keys→ Line keys as Function Keys→ Line

Key1(for example)

2. Press  and  key to select the Line in the Type field.

3. Select the Account ID

4. Press  or Save soft key to save the configuration

Then the selected Line Key will work as Line.

### To configure Line Feature via Web interface

1. Click Function Keys→ Line Key.

2. Select the wanted Line Key and set as Line.

3. Select the Account.

4. Click the  button to save the configuration.

Line	Type	Mode	Value	Label	Account	Extension
Key1	Line ▼	Default ▼		243	Account 1 ▼	
Key2	N/A ▼	Default ▼			Account 1 ▼	

## Shared Line

Htek IP Phone supports “Shared Call Appearance” by Broadsoft and XCast standard. This feature allows members of the SCA group to shared SIP lines and provides status monitoring (idle, active, progressing, hold) of the shared line. When there is an incoming call designated for the SCA group, all of the members of the group will be notified of an incoming call and will be able to answer the call from the phone with the SCA extension registered in the group.

All the users that belong to the same SCA group will be notified by visual indicator when a user seizes the line and places an outgoing call, and all the users of this group will not be able to seize the line until the line goes back to an idle state or when the call is placed on hold (with the exception of when multiple call appearances are enabled on the server side).

In the middle of the conversation, there are two types of hold: Public Hold and Private Hold. When a member of the group places the call on public hold, the other users of the SCA group will be notified of this by the red-flashing button and they will be able to resume the call from their phone by pressing the line button. However, if this call is placed on private-hold, no other member of the SCA group will be able to resume that call.

To enable shared call appearance, the user would need to register the shared line account on the phone. In addition, they would need to navigate to “Account”→ “Basic” and “Profile”→ “Advanced” on the webpage and set the line to “Shared Line” and “SIP Server Type”, and configure the line key or Line Key as “Line” type with the desired account on webpage or LCD. If the user requires more shared call appearances, the user can configure multiple line keys (Function Keys→ Line Key) to be “Line” type associated with the account.

This feature is very useful in the boss and secretary scenario. For example, the secretary can share the boss' extension number on her phone. When there is an incoming call to the extension number of the boss, both the phones of the boss and the secretary will ring simultaneously. Either the boss or the secretary can answer the call. Calls on shared line can be placed on hold or barged in.

### To enable share line via Web interface

1. Click Account→ Basic
2. Select the desired account from the pull-down list of Account in the Account field.
3. Select SCA for the Shared Line

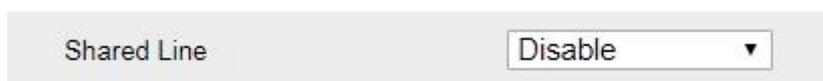

A screenshot of a web interface showing a configuration field for "Shared Line". The field is a light gray box with the text "Shared Line" on the left and a dropdown menu on the right. The dropdown menu is currently set to "Disable" and has a small downward-pointing triangle next to it.

4. Click Profile→ Advanced
5. Select the desired profile from the pull-down list of Profile in the Profile field.
6. Select the SIP Server Type

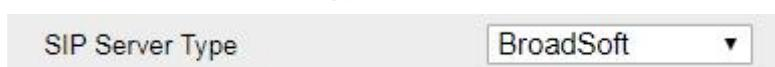

A screenshot of a web interface showing a configuration field for "SIP Server Type". The field is a light gray box with the text "SIP Server Type" on the left and a dropdown menu on the right. The dropdown menu is currently set to "BroadSoft" and has a small downward-pointing triangle next to it.

7. Click  to save the configuration.

### To configure Line key via Phone interface

1. Press Menu→ Features→ Function Keys→ Line keys as Function Keys→ Line

Key1(for example)

2. Press  and  key to select the Line in the Type field.
3. Select the Account ID
4. Press  or Save soft key to save the configuration

Then the selected Line Key will work as Line.

### To configure Line key via Web interface

1. Click Function Keys→ Line Key.
2. Select the wanted Line Key and set as Line.
3. Select the Account.
4. Click the  button to save the configuration.

Line	Type	Mode	Value	Label	Account	Extension
Key1	Line ▼	Default ▼		243	Account 1 ▼	
Key2	N/A ▼	Default ▼			Account 1 ▼	

#### Note:

**This feature is not available on all servers. For more information, contact your system administrator.**

## Speed Dial

With this feature, you can dial one number by pressing the configured Speed Dial key.

### To configure Speed Dial feature via Phone interface

1. Press Menu→ Features→ Function Keys→ Line keys as Function Keys→ Line

Key2(for example)

2. Press  and  key to select the Speed Dial in the Type field.
3. Enter the targeted Number in the Value field.
4. Select the Account ID
5. Press  or Save soft key to save the configuration

Then the selected Line Key will work as Speed Dial.

### To configure Speed Dial feature via Web interface

1. Click Function Keys→ Line Key.
2. Select the wanted Line Key and set as Speed Dial.
3. Enter the desired phone number in the Value field.

4. Select the Account

5. Click the  button to save the configuration.

Line	Type	Mode	Value	Label	Account	Extension
Key1	Line	Default		243	Account 1	
Key2	Speed Dial	Default	245		Account 1	

## BLF

You can use the BLF (Busy Lamp Field) feature to monitor a specific extension number whether the extension is busy or free.

1. When the extension you are monitoring is idle, the light is steady green.
2. When the monitored extension is ringing, the light is blinking red, press the BLF key to pick the phone up directly.
3. When the monitored extension is calling or in a conversation, the light is steady red.

### To configure a BLF key via Phone interface

1. Press Menu→ Features→ Function Keys→ Line Keys as Function Keys→ Line

Key2(for example).

2. Press  and  key to select the BLF in the Type field.
3. Enter the targeted Number in the Value field.
4. Press  and  key to select the Account ID.
5. Enter the Pickup Code.
6. Press  or Save soft key to save the configuration

### To configure a BLF key via Web interface

1. Click Function Keys→ Line Key.
2. Select the desired Line Key and select BLF in the Type field.
3. Enter the monitored phone number in the Value field.
4. Select the Account
5. Fill the Extension.
6. Click  to save the configuration.

Line	Type	Mode	Value	Label	Account	Extension
Key1	Line	Default		243	Account 1	
Key2	BLF	Default	245		Account 1	

**Note:**

This feature is not available on all servers. For more information, contact your system administrator.

After setting the BLF key, do not need to restart the phone.

## Visual Alert for BLF Pickup

If this option is on, when you use the BLF feature to monitor a specific phone whether it is busy or free, you can see this message on the LCD, as shown in the following figure.



### To configure Visual Alert for BLF Pickup via Web interface

1. Click Setting→ Features→ Call Pickup→ Visual Alert for BLF Pickup
2. Select Enable or Disable for Visual Alert for BLF Pickup.
3. Click  to save the configuration.



## Audio Alert for BLF Pickup

If this option is on, when you use the BLF feature to monitor a specific phone whether it is busy or free, you can hear beep.

### To configure Audio Alert for BLF Pickup via Web interface

1. Click Setting→ Features→ Call Pickup→ Audio Alert for BLF Pickup
2. Select Enable or Disable for Audio Alert for BLF Pickup
3. Click  to save the configuration.

**Call Pickup**

Call Pickup Mode FAC ▼

Direct Call Pickup Disable ▼

Direct Call Pickup Code

Group Call Pickup Disable ▼

Group Call Pickup Code

Visual Alert for BLF Pickup Disable ▼

Audio Alert for BLF Pickup Enable ▼

## BLF List

### To configure BLF List via Web interface:

1. Login and click Account→ Basic
2. Select the desired account from the pull-down list of Account in the Account field.
3. Fill the Eventlist BLF URL.

Eventlist BLF URL

4. Click Profile→ Advanced
5. Select the desired profile from the pull-down list of Profile in the Profile field.
6. Select the SIP Server Type

SIP Server Type BroadSoft ▼

7. Click  to save the configuration.

### 8. To configure BLF List Keys

- 8.1 Click Function Keys→ Line Key
- 8.2 Select the desired Line Key and select the BLF List in the Type Field.
- 8.3 Select the Account

- 8.4 Click  to save the configuration.

Line	Type	Mode	Value	Label	Account	Extension
Key1	Line ▼	Default ▼	<input type="text"/>	243	Account 1 ▼	<input type="text"/>
Key2	BLF List ▼	Default ▼	<input type="text"/>	<input type="text"/>	Account 1 ▼	<input type="text"/>

For more information, please check [BLF List](#).

## Voice Mail

This phone supports Voicemail, and when there is a message, the message key  will flash green. Moreover, when you pick up the handset, or press speaker key, you will hear some faster busy tone.



### To configure the Voice Mail feature via Phone interface:

1. Press Menu → Messages → Voice Mail → Set Voice Mail.
2. Enter the Account No.
3. Press  or Save soft key to save the configuration

### To configure the Voice Mail feature via Web interface:

1. Click Account → Basic.
2. Select the desired account from the pull-down list of Account in the Account field.
3. Fill the Voice Mail UserID.
4. Click  to save the configuration.

Voice Mail UserID

### To configure a Voice Mail key via Phone interface:

1. Press Menu → Features → Function Keys → Line Keys as Function Keys → Line Key2(for example).
2. Press  and  key to select the Voice Mail in the Type field.
3. Enter the targeted feature codes in the Value field.
4. Press  and  key to select the Account ID.

5. Press  or Save soft key to save the configuration

**To configure a Voice Mail Key via Web interface:**

1. Click Function Keys→ Line Key.
2. Select the wanted Line Key and set as Voice Mail.
3. Enter the desired voicemail feature codes in the Value field.
4. Select the Account
5. Click  to save the configuration.

Line	Type	Mode	Value	Label	Account	Extension
Key1	Line ▼	Default ▼		243	Account 1 ▼	
Key2	Voice Mail ▼	Default ▼	*97		Account 1 ▼	

**To leave a voice mail:**

You can leave a voice mail when the receiver is busy or its inconvenient for them to answer the call. Follow the voice prompt from the system server to leave a voice mail, and then hang up.

**To listen to voice mails:**

When the phone interface prompts receiving new voice mail's icon, the power indicator LED flashes red(Setting→ Preference→ LED Status Setting: Voice Message Status: Yes) and the voice message button flashes green.

1. Pressing  or the targeted Line Key to dial out the voice mail access code.
2. Follow the voice prompt to listen to voice mail.

**To view the voicemail via Phone interface:**

Press Menu→ Messages→ Voice Mail→ View Voice Mail.

The LCD screen displays the amount of new and old voice mails.

View Voice Mail	
1.088:	1 new, 0 old
2.Account2:	Not Registered
3.Account3:	Not Registered
4.Account4:	Not Registered
<input type="button" value="Back"/>	

**Note:**

This feature is not available on all servers. For more information, contact your system administrator.

Before listening to voice mails, make sure the voice mail access code has been configured.

When all new voice mails are retrieved, the power indicator LED, voice mail indicator LED and targeted Line Key LED will go out.

## Direct Pickup

With this feature, you can pick up the set line when it ringing.

### To configure Direct Pickup code via Web interface

1. Click Account→ Basic.
2. Select the desired account from the pull-down list of Account in the Account field.
3. Fill the Direct Call Pickup Code
4. Click  to save the configuration.

Direct Call Pickup Code

### To configure Direct Pickup feature via Phone interface

1. Press Menu→ Features→ Function Keys→ Line Keys as Function Keys→ Line Key2(for example)
2. Press  and  key to select the PickUP in the Type field.
3. Enter the targeted Number in the Value field.
4. Press  and  key to select the Account ID.
5. Press  or Save soft key to save the configuration

Then the selected Line Key will work as Direct Pickup.

### To configure Direct Pickup feature via Web interface

1. Click Function Keys→ Line Key.
2. Select the wanted Line Key and set as Direct Pickup.
3. Enter the desired phone number in the Value field.
4. Select the Account
5. Click  to save the configuration.

Line	Type	Mode	Value	Label	Account	Extension
Key1	Line ▼	Default ▼	<input type="text"/>	243	Account 1 ▼	<input type="text"/>
Key2	Direct Pickup ▼	Default ▼	245	<input type="text"/>	Account 1 ▼	<input type="text"/>

## Group Pickup

With this feature, you can pick up the specified group that you want incoming calls.

### To configure Group Pickup code via Web interface

1. Click Account→ Basic.
2. Select the desired account from the pull-down list of Account in the Account field.
3. Fill the Group Call Pickup Code
4. Click  to save the configuration.

Group Call Pickup Code	<input type="text"/>
------------------------	----------------------

### To configure the Group Pickup via Phone interface

1. Press Menu→ Features→ Function Keys→ Line Keys as Function Keys→ Line Key2(for example)
2. Press  and  key to select the Group in the Type field.
3. Enter the targeted Number in the Value field.
4. Press  and  key to select the Account ID.
5. Press  or Save soft key to save the configuration

### To configure the Group Pickup via Web interface

1. Click Function Keys→ Line Key.
2. Select the desired Line Key and select Group Pickup in the Type field.
3. Enter the desired phone number in the Value field.
4. Select the Account
5. Click  to save the configuration.

Line	Type	Mode	Value	Label	Account	Extension
Key1	Line ▼	Default ▼		243	Account 1 ▼	
Key2	Group Pickup ▼	Default ▼	8038		Account 2 ▼	

## Call Park

With this feature, you can put a call on hold and continue the conversation from another phone.

### To configure the Call Park via Phone interface

1. Press Menu→ Features→ Function Keys→ Line Keys as Function Keys→ Line Key2(for example)

2. Press  and  or press Switch soft key to select the Call Park in the Type field.
3. Enter the call park code in the Value field
4. Press  and  key to select the Account ID.
5. Press  or Save soft key to save the configuration

#### To configure the Call Park via Web interface

1. Click Function Keys→ Line Key.
2. Select the desired Line Key and select Call Park in the Type field.
3. Enter the call park code in the Value field.
4. Select the Account.
5. Click the  button to save the configuration.

Line	Type	Mode	Value	Label	Account	Extension
Key1	Line ▼	Default ▼		088	Auto ▼	
Key2	Call Park ▼	Default ▼	SP10		Account 1 ▼	

For More information for Call Park, please see: [Call Park](#)

## Intercom

When use the intercom feature, you can quickly get access connect to the configured one.

#### To configure Intercom feature via Phone interface

1. Press Menu→ Features→ Function Keys→ Line Keys as Function Keys→ Line Key2(for example)
2. Press  and  key to select the Intercom in the Type field.
3. Enter the intercom codes followed by desired number.
4. Select the Account ID.
5. Press  or Save soft key to save the configuration

Then the selected Line Key will work as Intercom.

#### To configure Intercom feature via Web interface

1. Click Function Keys→ Line Key.
2. Select the wanted Line Key and set as Intercom.
3. Enter the intercom codes followed by desired number in the Value field.
4. Select the Account.
5. Click the  button to save the configuration.

Line	Type	Mode	Value	Label	Account	Extension
Key1	Line	Default		088	Auto	
Key2	Intercom	Default	*11012		Account 1	

If you want to achieve the Intercom feature, you must enable the “Allow Auto Answer by Call-Info”

1. Login webpage, and click Profile→ Advanced
2. Select the desired profile from the pull-down list of Profile in the Profile field.
3. Select Yes for the “Allow Auto Answer By Call-Info”
4. Click the  button to save the configuration.

Allow Auto Answer By Call-Info  No  Yes

**Note:**

**This feature is not available on all servers. For more information, contact your system administrator.**

## Intercom Barge

If this option is enabled, when there is an active call and an incoming intercom call arrives, the previous call will be put on hold and the intercom call will be answered

1. Login webpage, and click Setting→ Preference
2. Set On or Off for Intercom Barge.
3. Click  for the setting.

Intercom Barge  On  Off 

**Note:**

**This feature is not available on all servers. For more information, contact your system administrator.**

## DTMF

When the key is configured as DTMF key, you are allowed to send out the desired DTMF number during the conversation.

To use this feature, you should sure that the DTMF Tone is on.

**To configure the DTMF Tone via Web interface**

1. Click Setting→ Preference
2. Select On for Keypad DTMF Tone.
3. Click  to save the configuration.

Keypad DTMF Tone  On  Off 

### To configure the DTMF via Phone interface

1. Press Menu→ Features→ Function Keys→ Line Keys as Function Keys→ Line Key2(for example)
2. Press  and  key to select the DTMF in the Type field.
3. Enter the Value field with the desired DTMF number.
4. Press  or Save soft key to save the configuration

### To configure the DTMF via Web interface

1. Click Function Keys→ Line Key.
2. Select the desired Line Key and select DTMF in the Type field.
3. Fill the Value field with the desired DTMF number.
4. Click the  to save the configuration.

Line	Type	Mode	Value	Label	Account	Extension
Key1	Line	Default		243	Account 1	
Key2	DTMF	Default	0012		Account 1	

## Prefix

If the key is configured as Prefix key, you can set the number prefix (e.g. Before the number plus 9), then you don't input 9, press the key and 9 will display on the LCD interface.

### To configure the Prefix via Phone interface

1. Press Menu→ Features→ Function Keys→ Line Keys as Function Keys→ Line Key2(for example)
2. Press  and  key to select the Prefix in the Type field.
3. Enter the Value field with number that you want to set as prefix
4. Press  or Save soft key to save the configuration

### To configure the Prefix via Web interface

1. Click Function Keys→ Line Key.
2. Select the desired Line Key and select Prefix in the Type field.
3. Fill the Value field with number that you want to set as prefix.

- Click  to save the configuration.

Then when you press this key, the set value is input directly.

Line	Type	Mode	Value	Label	Account	Extension
Key1	Line	Default		243	Account 1	
Key2	Prefix	Default	9		Account 1	

## Local Group

When use the Local Group feature, press the key and enter the Local Contacts interface quickly.

### To configure the Local Group via Phone interface

- Press Menu→ Features→ Function Keys→ Line Keys as Function Keys→ Line

Key2(for example)

- Press and key to select the Local Group in the Type field.

- Press or Save soft key to save the configuration

### To configure the Local Group via Web interface

- Click Function Keys→ Line Key.
- Select the desired Line Key and select Local Group in the Type field.
- Click  to save the configuration.

Then you can press the Local Group key to quickly enter the Local Contacts interface.

Line	Type	Mode	Value	Label	Account	Extension
Key1	Line	Default		243	Account 1	
Key2	Local Group	Default			Account 1	

## XML Group

When use the XML Group feature, press the key and enter the Remote Contacts interface quickly.

### To configure the XML group via Phone interface

- Press Menu→ Features→ Function Keys→ Line Keys as Function Keys→ Line

Key2(for example)

2. Press  and  key to select the XML Group in the Type field.
3. Press  and  key to select the Account ID.
4. Press  or Save soft key to save the configuration

#### To configure the XML Group via Web interface

1. Click Function Keys→ Line Key.
2. Select the desired Line Key and select XML Group in the Type field.
3. Select the desired remote phonebook in the Account field.
4. Click  to save the configuration.

Line	Type	Mode	Value	Label	Account	Extension
Key1	Line ▼	Default ▼		243	Account 1 ▼	
Key2	XML Group ▼	Default ▼			remote pho ▼	

## XML Browser

You can use this key to access the Xml browser quickly. The Xml browser allows you to create custom services which meet your functional requirements on the server. You can customize practical applications, such as weather report, stock information, Google search, etc.

#### To configure the XML Browser via Phone interface

1. Press Menu→ Features→ Function Keys→ Line Keys as Function Keys→ Line Key2(for example)
2. Press  and  key to select the XML Browser in the Type field.
3. Fill the access URL for xml browser in the Value field.
4. Press  or Save soft key to save the configuration

#### To configure the XML Browser via Web interface

1. Click Function Keys→ Line Key.
2. Select the desired Line Key and select Xml Browser in the Type field.
3. Fill the access URL for xml browser in the Value field. (e.g.: <http://10.2.0.140/XMLBrowser/TextMenu.xml>)
4. Click  button to save the configuration.

Line	Type	Mode	Value	Label	Account	Extension
Key1	Line	Default		243	Account 1	
Key2	XML Browser	Default	http://10.2.0		Account 1	

## LDAP

When use the LDAP feature, you can get the LDAP Phonebook directly.

### To configure the LDAP via Phone interface

1. Press Menu→ Features→ Function Keys→ Line Keys as Function Keys→ Line

Key2(for example)

2. Press and key to select the LDAP in the Type field.

3. Press or Save soft key to save the configuration

### To configure the LDAP via Web interface

1. Click Function Keys→ Line Key.

2. Select the desired Line Key and select LDAP in the Type field.

3. Click  to save the configuration.

Line	Type	Mode	Value	Label	Account	Extension
Key1	Line	Default		243	Account 1	
Key2	LDAP	Default			Account 1	

## Network Directories

When using the BroadSoft Directory feature, by just pressing the key you can enter the Broadsoft Contacts interface its fast and convenient.

### To configure the Network Directories via Phone interface

1. Press Menu→ Features→ Function Keys→ Line Keys as Function Keys→ Line

Key2(for example)

2. Press and key to select the BS Group in the Type field.

3. Press and key to select the Account ID.

4. Press or Save soft key to save the configuration

**To configure the Network Directories via Web interface**

1. Click Function Keys→ Line Key.
2. Select the desired Line Key and select Network Directories in the Type field.
3. Select the Account.
4. Click the button to save the configuration.

Line	Type	Mode	Value	Label	Account	Extension
Key1	Line	Default		243	Account 1	
Key2	Network Direct	Default			Account 1	

Then you can press the Network Directories key to quickly enter the Broadsoft Contacts interface.

**To configure the Network Group via Web interface**

1. Click Function Keys→ Line Key.
2. Select the desired Line Key and select Network Group in the Type field.
3. Select All Contacts/ Group/ Interoperability/ GroupCommon/ EnterpriseCommon/ Personal/ Custom Directories for the Account.
4. Click the button to save the configuration.

Line	Type	Mode	Value	Label	Account	Extension
Key1	Line	Default		243	Account 1	
Key2	Network Group	Default			All Contact	

Then you can press the Network Group key to quickly enter the selected secondary directory of Broadsoft Contacts.

For more details, refer to [Broadsoft Directory](#).

## Conference

The Htek IP Phone supports up to 5-way conference. You are allowed to configure the line key to be used as a conference key.

**To configure the Conference via Phone interface**

1. Press Menu→ Features→ Function Keys→ Line Keys as Function Keys→ Line Key2(for example)

2. Press and key to select the Conf in the Type field.

3. Press or Save soft key to save the configuration

### To configure Conference via Web interface

1. Click Function Keys→ Line Key.
2. Select the desired Line Key and select Conference in the Type field.
3. Click the button to save the configuration.

Line	Type	Mode	Value	Label	Account	Extension
Key1	Line	Default		243	Account 1	
Key2	Conference	Default			Account 1	

## Forward

If the key is configured as Forward key, press this key under the idle status, the IP phone will turn to the Always Forward interface and you can set the Forward to number, then when there is any call to that number it will be forwarded to the set number automatically.

### To configure the Forward via Phone interface

1. Press Menu→ Features→ Function Keys→ Line Keys as Function Keys→ Line Key2(for example)

2. Press and key to select the Forward in the Type field.
3. Enter the Number to forward to in the Value field.
4. Press or Save soft key to save the configuration

### To configure Forward via Web interface

1. Click Function Keys→ Line Key.
2. Select the desired Line Key and select Forward in the Type field.
3. Enter the Value field with the number you want to forward to.
4. Click the button to save the configuration.

Line	Type	Mode	Value	Label	Account	Extension
Key1	Line	Default		243	Account 1	
Key2	Forward	Default	245		Account 1	

## Transfer

You are able to configure the key as a transfer key to perform the Attended/Semi-Attended Transfer.

#### To configure the Transfer via Phone interface

1. Press Menu→ Features→ Function Keys→ Line Keys as Function Keys→ Line

Key2(for example)

2. Press  and  key to select the Transfer in the Type field.

3. Enter the Number to transfer to in the Value field.

4. Press  or Save soft key to save the configuration

#### To configure Transfer via Web interface

1. Click Function Keys→ Line Key.

2. Select the desired Line Key and select Transfer in the Type field.

3. Enter the Value field with the number that wanted transfer to

4. Click the  button to save the configuration.

Line	Type	Mode	Value	Label	Account	Extension
Key1	Line	Default		243	Account 1	
Key2	Transfer	Default	245		Account 1	

## Hold

The key can be configured as a hold key. You can use this key to hold and resume a call during the conversation.

#### To configure the Hold via Phone interface

1. Press Menu→ Features→ Function Keys→ Line Keys as Function Keys→ Line

Key2(for example)

2. Press  and  key to select the Hold in the Type field.

3. Press  or Save soft key to save the configuration

#### To configure the Hold via Web interface

1. Click Function Keys→ Line Key.

2. Select the desired Line Key and select Hold in the Type field.

3. Click the  button to save the configuration.

Line	Type	Mode	Value	Label	Account	Extension
Key1	Line	Default		243	Account 1	
Key2	Hold	Default			Account 1	

## DND

If the key is configured as DND key, allows you to activate the DND function immediately when you press it and the phone will reject all incoming calls automatically. Press it again to deactivate DND mode.

### To configure the DND via Phone interface

1. Press Menu→ Features→ Function Keys→ Line Keys as Function Keys→ Line

Key2(for example)

2. Press  and  key to select the DND in the Type field.

3. Press  or Save soft key to save the configuration

### To configure DND via Web interface

1. Click Function Keys→ Line Key.

2. Select the desired Line Key and select DND in the Type field.

3. Click the  button to save the configuration.

Line	Type	Mode	Value	Label	Account	Extension
Key1	Line	Default		243	Account 1	
Key2	DND	Default			Account 1	

### To enable DND feature

Press the DND key when the phone is idle status, and then DND icon is shown on the LCD.

### To disable DND feature

Press the DND key again, then there is no DND icon on the LCD.

## Redial

If the key is configured as Redial key, you can redial the last placed call from the IP Phone.

### To configure Redial via Phone interface

1. Press Menu→ Features→ Function Keys→ Line Keys as Function Keys→ Line Key2(for example)

2. Press  and  key to select the Redial in the Type field.

3. Press  or Save soft key to save the configuration

#### To configure Redial via Web interface

1. Click Function Keys→ Line Key
2. Select the desired Line Key and select Redial in the Type field.
3. Click the  button to save the configuration.

Line	Type	Mode	Value	Label	Account	Extension
Key1	Line ▼	Default ▼		243	Account 1 ▼	
Key2	Redial ▼	Default ▼			Account 1 ▼	

## SMS

### Send SMS

#### To send SMS via Web interface

1. Click Setting→ SMS
2. Select the Account (from which account the SMS sent)
3. Enter the target Number
4. Input the content of SMS, and click .

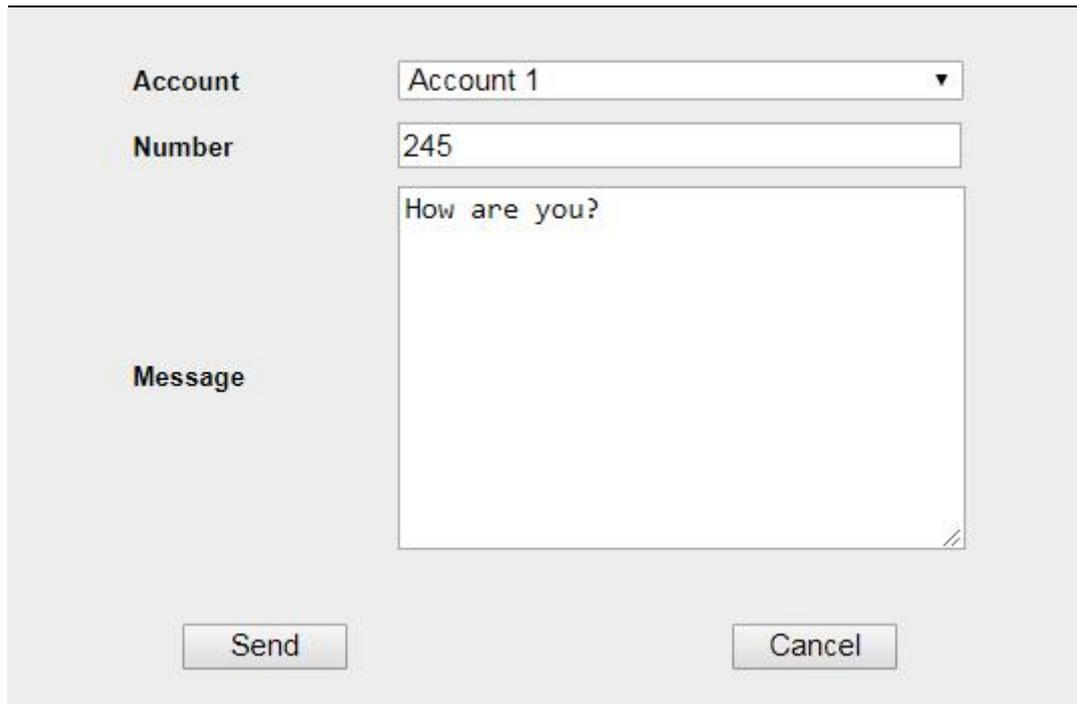

**To send SMS via Phone interface:**

1. Click Menu→ Messages→ Text Message→ Set SMS
2. Enter the contents in the white field.
3. Press the Send button
4. Select the account in the From field (from which account the SMS sent)
5. Enter the target number in the To field (to which account the number sent)
6. Press the Send button.

## Set SMS Line Key

**To configure the SMS via Phone interface**

1. Press Menu→ Features→ Function Keys→ Line Keys as Function Keys→ Line Key2(for example)

2. Press  and  key to select the SMS in the Type field.

3. Press  or Save soft key to save the configuration

**To configure the SMS via Web interface**

1. Click Function Keys→ Line Key.
2. Select the desired Line Key and select SMS in the Type field.
3. Click  to save the configuration.

Line	Type	Mode	Value	Label	Account	Extension
Key1	Line	Default		243	Account 1	
Key2	SMS	Default			Account 1	

## Record

With record feature, you can record your calls by pressing the record key .

### To configure the Record via Phone interface

1. Press Menu→ Features→ Function Keys→ Line Keys as Function Keys→ Line

Key2(for example)

2. Press and key to select the Record in the Type field.

3. Press or Save soft key to save the configuration



### To configure the Record via Web interface

1. Click Function Keys→ Line Key.

2. Select the desired Line Key and select Record in the Type field.

3. Click the  button to save the configuration.

Line	Type	Mode	Value	Label	Account	Extension
Key1	Line	Default		243	Account 1	
Key2	Record	Default			Account 1	

#### Note:

Please contact the system administrator whether support this feature or not.

## URL Record

The phone sends HTTP URL request to trigger a recording. Contact your system administrator for the predefined URL.

### To configure the URL Record via Phone interface

1. Press Menu→ Features→ Function Keys→ Line Keys as Function Keys→ Line Key2(for example)

2. Press  and  key to select the URL Record in the Type field.

3. Enter the predefined URL in the Value field.

4. Press  or Save soft key to save the configuration

### To configure the URL Record via Web interface

1. Click Function Keys→ Line Key.

2. Select the desired Line Key and select URL Record in the Type field.

3. Fill the predefined URL in the Value field.

4. Click the  button to save the configuration.

Line	Type	Mode	Value	Label	Account	Extension
Key1	Line ▼	Default ▼		243	Account 1 ▼	
Key2	URL Record ▼	Default ▼	http://10.2.0		Account 1 ▼	

## Paging

With this feature, you can call a paging group directly.

### To configure the Paging via Phone interface

1. Press Menu→ Features→ Function Keys→ Line Keys as Function Keys→ Line Key2(for example)

2. Press  and  key to select the Paging in the Type field.

3. Enter the paging code followed the number in the Value field.

4. Press  and  key to select the Account ID.

5. Press  or Save soft key to save the configuration

### To configure the Paging via Web interface

1. Click Function Keys→ Line Key.

2. Select the desired Line Key and select Paging in the Type field.

3. Enter the paging code followed the number in the Value field.

4. Select the Account.

5. Click the  button to save the configuration.

Line	Type	Mode	Value	Label	Account	Extension
Key1	Line	Default		243	Account 1	
Key2	Paging	Default	*88039		Account 2	

## Group Listening

With this feature, when you have an active call, you can listen using Handset and Free-speaker, but only can use the handset to speak.

### To configure the Group Listening via Phone interface

1. Press Menu→ Features→ Function Keys→ Line Keys as Function Keys→ Line

Key2(for example)

2. Press  and  key to select the Group Listening in the Type field.

3. Press  or Save soft key to save the configuration

### To configure the Group Listening via Web interface

1. Click Function Keys→ Line Key.

2. Select the desired Line Key and select Group Listening in the Type field.

3. Click  to save the configuration.

Line	Type	Mode	Value	Label	Account	Extension
Key1	Line	Default		243	Account 1	
Key2	Group Listenin	Default			Account 1	

## Public Hold

The key can be configured as a public hold key. During a conversation, all members belonging to that particular SLA group can use this key to hold or resume a call.

### To configure the Public Hold via Phone interface

1. Press Menu→ Features→ Function Keys→ Line Keys as Function Keys→ Line

Key2(for example)

- Press and key to select the Public Hold in the Type field.
- Press or Save soft key to save the configuration

#### To configure the Public Hold via Web interface

- Click Function Keys→ Line Key.
- Select the desired Line Key and select Public Hold in the Type field.
- Click the  button to save the configuration.

Line	Type	Mode	Value	Label	Account	Extension
Key1	Line ▼	Default ▼		243	Account 1 ▼	
Key2	Public Hold ▼	Default ▼			Account 1 ▼	

## Private Hold

The key can be configured as a private hold key. During a conversation, all members belonging to that particular SLA group can use this key to hold the call, but only the initiator can resume the call.

#### To configure the Private Hold via Phone interface

- Press Menu→ Features→ Function Keys→ Line Keys as Function Keys→ Line Key2(for example)

- Press and key to select the Private Hold in the Type field.
- Press or Save soft key to save the configuration

#### To configure the Private Hold via Web interface

- Click Function Keys→ Line Key.
- Select the desired Line Key and select Private Hold in the Type field.
- Click the  button to save the configuration.

Line	Type	Mode	Value	Label	Account	Extension
Key1	Line ▼	Default ▼		243	Account 1 ▼	
Key2	Private Hold ▼	Default ▼			Account 1 ▼	

## Hot Desking

Hot Desking originates from the definition of being the temporary physical occupant of a work station or surface by a particular employee. A primary motivation for Hot Desking is cost reduction. This feature is regularly used in places where all employees are not in the office at the same time, or not in the office for a very long time, which means their personal offices are often vacant, consuming valuable space and resources.

You can use Hot Desking on the IP phone to logout the existing accounts and then log in a new account, which allows many users to share the phone resource in different times. To use this feature, first you need to configure a Hot Desking key in the advance settings.

This feature is supported on the version 1.0.3.82 or later

**To configure the Hot Desking via Phone interface**

1. Press Menu→ Features→ Function Keys→ Line Keys as Function Keys→ Line Key2(for example)

2. Press  and  key to select the Hot Desking in the Type field.

3. Press  or Save soft key to save the configuration

**To configure the Hot Desking via Web interface:**

1. Click Function Keys→ Line Key.
2. Select the desired Line Key and select Hot Desking in the Type field.
3. Click the  button to save the configuration.

Line	Type	Mode	Value	Label	Account	Extension
Key1	Line ▼	Default ▼		243	Account 1 ▼	
Key2	Hot Desking ▼	Default ▼			Account 1 ▼	

**To use the Hot Desking feature on the user interface:**

1. Press the Hot Desking key when the IP Phone is idle.
2. "Clear all other account config?" is shown on the screen, and press OK.
2. Enter the Extension number and password
3. Click Save soft key

You can see the account information which has changed.

**Note:**  
**This feature is not available on all servers. For more information, contact your system administrator.**

## ACD

ACD feature is often used in offices for customer service, such as call center. The ACD system handles large volumes of incoming calls from callers who have no need to talk to a specific person but who require assistance from any of the different personnel at the earliest point. The ACD feature on the Htek IP Phone allows the ACD system to distribute

calls from large volumes of incoming calls to the registered IP phone users. To use this feature, first you should configure an ACD key in the advance settings.

#### To configure the ACD via Phone interface

1. Press Menu→ Features→ Function Keys→ Line Keys as Function Keys→ Line Key2(for example)

2. Press  and  key to select the ACD in the Type field.

3. Select the desired account in the Account ID field.

4. Press  or Save soft key to save the configuration

#### To configure the ACD via Web interface:

1. Click Function Keys→ Line Key.

2. Select the desired Line Key and select ACD in the Type field.

3. Select the desired account from the pull-down list of Account field.

4. Click the  button to save the configuration.

Line	Type	Mode	Value	Label	Account	Extension
Key1	Line ▼	Default ▼		243	Account 1 ▼	
Key2	ACD ▼	Default ▼			Account 1 ▼	

#### Note:

**This feature is not available on all servers. For more information, contact your system administrator.**

## Zero Touch

You can use this key feature to configure auto provision and network parameters quickly.

This feature is supported on the version 1.0.3.82 or later

#### To configure the Zero Touch via Phone interface

1. Press Menu→ Features→ Function Keys→ Line Keys as Function Keys→ Line Key2(for example)

2. Press  and  key to select the Zero Touch in the Type field.

3. Press  or Save soft key to save the configuration

#### To configure the Zero Touch via Web interface:

1. Click Function Keys→ Line Key.

2. Select the desired Line Key and select Zero Touch in the Type field.

3. Click the  button to save the configuration.

Line	Type	Mode	Value	Label	Account	Extension
Key1	Line ▼	Default ▼		243	Account 1 ▼	
Key2	Zero Touch ▼	Default ▼			Account 1 ▼	

**To use the zero touch feature on the user interface:**

1. Press the Zero Touch key when the IP Phone is idle.
2. Press the OK soft key and the IP Phone will enter the WAN Port interface; you can change the WAN Type by pressing the Navigation keys.
3. Press the Next soft key to enter Network interface, then you can configure some information.
4. Press the Next soft key again, you can configure Auto Provision information.
5. When you finish the setting, you can press the OK to accept the changes.

**Note:**

**This feature is not available on all servers. For more information, contact your system administrator.**

## Multicast Paging

You can use multicast paging to quickly and easily forward out time sensitive announcements to people within the multicast group. You can configure a multicast paging key or a paging list key on the phone, which allows you to send a Real Time Transport Protocol (RTP) stream to the pre-configured multicast address/addresses without involving SIP signaling. You can configure the phone to receive an RTP stream from pre-configured multicast listening address/addresses without involving SIP signaling. You can specify up to 10 multicast listening addresses.

## Sending RTP Stream

**To configure a Multicast Paging key via Phone interface**

1. Press Menu→ Features→ Function Keys→ Line Keys as Function Keys→ Line Key2(for example).
2. Press  and  or Switch soft key to select the Multicast Paging in the Type field.
3. Enter the multicast IP address and port number (e.g., 224.5.6.20:2000) in the Value field. The valid multicast IP addresses range from 224.0.0.0 to 239.255.255.255.
4. Press  or Save soft key to save the configuration

**To configure a Multicast Paging key via Web interface**

1. Click Function Keys→ Line key :

2. Select the desired Line Key and select Multicast Paging in the Type field.
3. Enter the multicast IP address and port number (e.g., 224.5.6.20:2000) in the Value field. The valid multicast IP addresses range from 224.0.0.0 to 239.255.255.255.
4. Click the  button to save the configuration.

Line	Type	Mode	Value	Label	Account	Extension
Key1	Line	Default		243	Account 1	
Key2	MultiCast Pagi	Default	224.5.6.20:1		Account 1	

#### **Sending RTP Stream:**

Press the Multicast Paging key when the phone is idle.

The phone sends RTP to a preconfigured multicast address (IP: Port). Any phone in the local network then listens to the RTP on the preconfigured multicast address (IP:Port). For both sending and receiving of the multicast RTP, there is no SIP signaling involved.

The Multicast Paging key LED illuminates solid green.

## **Receiving RTP Stream**

You can configure the phone to receive a Real Time Transport Protocol (RTP) stream from the pre-configured multicast address/addresses without involving SIP signaling. You can specify up to 10 multicast addresses that the phone listens to on the network.

How the phone handles incoming multicast paging calls depends on Paging Barge and Paging Priority Active parameters configured via web user interface.

### **Paging Barge**

The paging barge parameter defines the priority of the voice call in progress. If the priority of an incoming multicast paging call is lower than that of the active call, it will be ignored automatically. If Disabled is selected from the pull-down list of Paging Barge, the voice call in progress will take precedence over all incoming multicast paging calls.

Valid values in the Paging Barge field:

- 1 to 10: Define the priority of the active call, 1 with the highest priority, 10 with the lowest.
- Disabled: The voice call in progress will take precedence over all incoming paging calls.

### **Paging Priority Active**

The paging priority active parameter decides how the phone handles incoming multicast paging calls when there is already a multicast paging call on the phone. If enabled, the phone will ignore incoming multicast paging calls with lower priorities, otherwise, the phone will answer incoming multicast paging calls automatically and place the previous

multicast paging call on hold. If disabled, the phone will automatically ignore all incoming multicast paging calls.

## Multicast Codec

You can only configure the codec via Web interface.

### To configure Multicast Codec via Web interface

1. Click Directory→ Multicast Paging
2. Select the desired codec from the pull-down list of Multicast Codec
3. Click the  button to save the configuration.

## Listening Address

### To configure multicast listening addresses via Web interface:

1. Click Directory→ Multicast Paging.
2. Select the desired value from the pull-down list of Paging Barge.
3. Select the desired value from the pull-down list of Paging Priority Active.
4. Enter the multicast IP address and port number (e.g., 224.5.6.20:2000) which the phone listens to for incoming RTP multicast in the Listening Address field.
5. Enter the label in the Label field.
6. Click  button to save the configuration.

Paging Barge

Paging Priority Active

Multicast Codec

Index	Listening Address	Label	Multi Priority
IP Address 1	<input type="text" value="224.5.6.20:2000"/>	<input type="text"/>	1
IP Address 2	<input type="text"/>	<input type="text"/>	2
IP Address 3	<input type="text"/>	<input type="text"/>	3
IP Address 4	<input type="text"/>	<input type="text"/>	4
IP Address 5	<input type="text"/>	<input type="text"/>	5
IP Address 6	<input type="text"/>	<input type="text"/>	6
IP Address 7	<input type="text"/>	<input type="text"/>	7
IP Address 8	<input type="text"/>	<input type="text"/>	8
IP Address 9	<input type="text"/>	<input type="text"/>	9
IP Address 10	<input type="text"/>	<input type="text"/>	10

**Note:**  
 The priorities of listening to multicasting addresses can be predefined: 1 being the highest priority, 10 with the lowest in priority order. Both the multicast paging sender and receiver's phones play a warning tone when establishing a multicast paging call. Listening to Multicasting addresses can be configurable via Web interface only.

## Upgrade

### Factory Reset

**To set Factory Reset via Phone interface**

1. Press Menu → Settings → Advanced Setting (default password: **admin**) → Phone

Setting→ Factory Reset

2. Press OK soft key in the warning page.

**To set Factory Reset via Web interface**

1. Click Management→ Upgrade

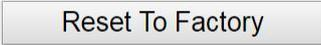
2. Click  and then confirm the setting.

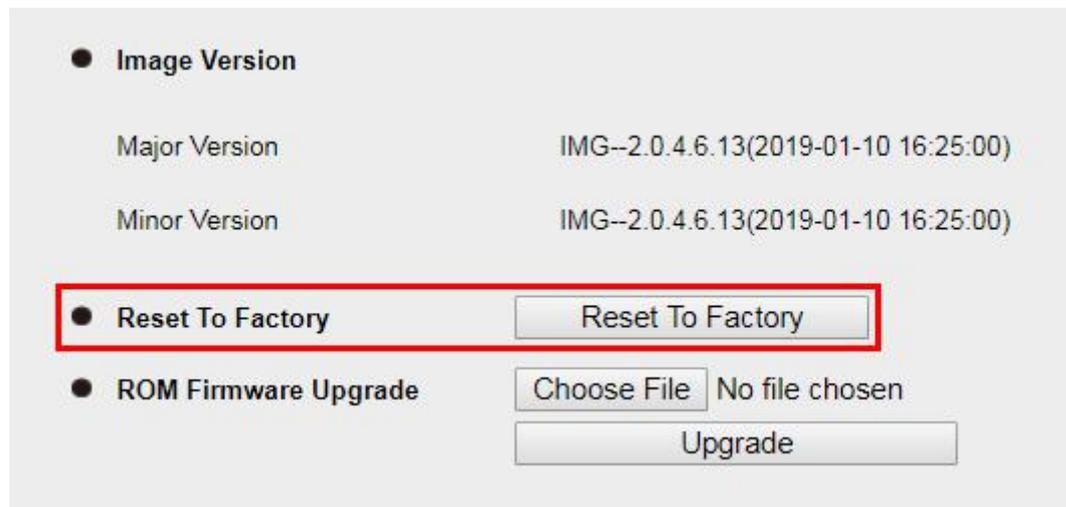

## Pcap Feature

**To use Pcap feature via Web interface:**

1. Click Management→ Tools

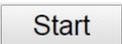
2. Click  and then operation the phone

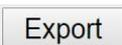
3. When finishing the operation, click  and then click .

4. Then you'll get the Pcap captures.

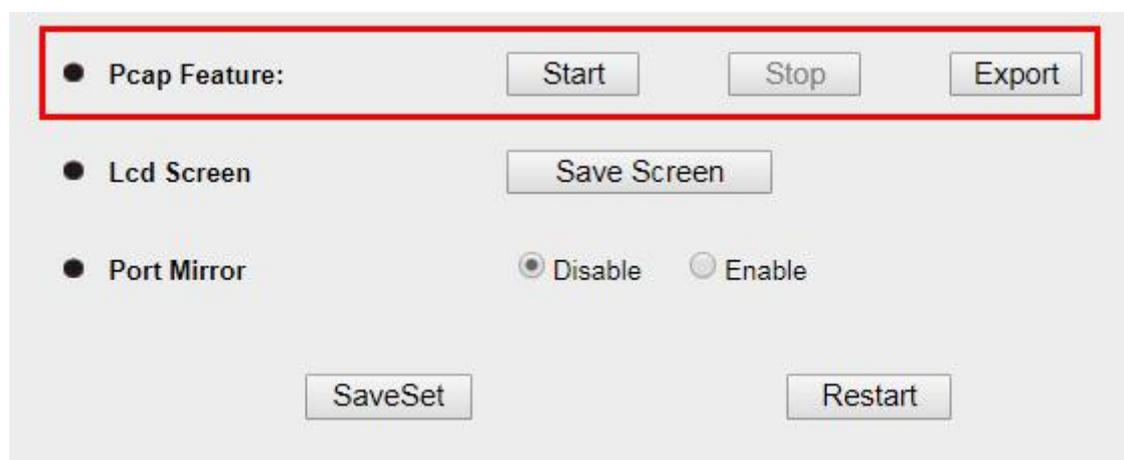

## System Log

### To download system log via Web interface:

1. Click Management→ Configuration
2. Select the Syslog Level

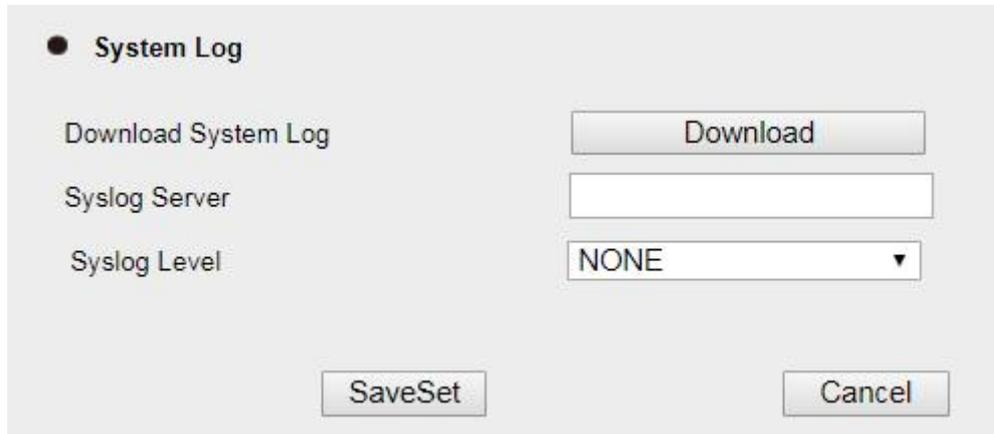

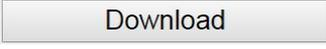
3. Click  of the System Log
4. Then you'll get a txt file: syslog.txt.

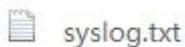

## Upgrade

To upgrade via HTTP, the “Management”→ “Auto Provision”→ “Firmware Upgrade”→ “Upgrade Mode” field needs to be set to HTTP, respectively. “Firmware Server Path” needs to be set to a valid URL of a HTTP server, server name can be in either FQDN or IP address format. Here are examples of some valid URL.

e.g. firmware.mycompany.com:5688/Htek

e.g. www.mycompany.com:5688/fm/Htek

e.g. 218.2.83.110

### Instructions for firmware upgrade via HTTP:

- (1) End users can choose to download the free HTTP server from <http://httpd.apache.org/> or use Microsoft IIS web server. Then setup HTTP server.
- (2) Unzip the firmware file and put all of them under the *root/fm* directory of the HTTP server.
- (3) Visit “http://192.168.0.254/fm/fw500M.rom” on localhost by browser to verify the HTTP Server. If visiting “http://192.168.0.254/fm/fw500M.rom” on another computer and it is not prompted to download fw500M.rom file on this computer, please check if the firewall is on or off (Suggest you turn off the firewall).

### To configure the server path via Web interface:

1. Click Management→ Auto Provision

2. Select the upgrade mode in the Upgrade Mode field
3. Enter the Firmware Server Path and Config Server Path (192.168.0.254 is HTTP server).
4. Enter the HTTP server's username and password (optional).
5. Click the  button to save the configuration.
6. Restart the UC921(G), IP Phone will restart and auto-get firmware files from HTTP server.

**Firmware Upgrade**

PnP Active  No  Yes ?

Upgrade Mode  TFTP  HTTP  FTP  HTTPS

Firmware Server Path

Config Server Path

Allow DHCP Option

To Override Server:  No  Yes

AUTO Upgrade:  No  Yes

Check for upgrade every  Minutes

Upgrade EXP Firmware  No  Yes

HTTP/FTP/HTTPS UserName

HTTP/FTP/HTTPS Password

HTTP server's username and password

Firmware/Config File Prefix

Firmware/Config File Postfix

**NOTES:**

- Htek recommends end-user use the Htek HTTP server. For large companies, we recommend to maintain their own TFTP/HTTP/FTP/HTTPS server for upgrade and provisioning procedures.
- Once a "Firmware Server Path" is set, user needs to update the settings and restart the IP Phone. If the configured firmware server is found and a new code image is available, the UC921(G) will attempt to retrieve the new image files by downloading them into the UC921(G)'s SDRAM. During this stage, the UC921(G)'s LEDs will blink fast until the checking/downloading process is completed. Upon verification of checksum, the new code image will then be saved into the Flash. If TFTP/HTTP/FTP/HTTPS fails for any reason (e.g. TFTP/HTTP/FTP/HTTPS server is not responding, there are no code image files available for upgrade, or checksum test fails, etc), the UC921(G) will stop the

TFTP/HTTP/FTP/HTTPS process and simply boot using the existing code image in the flash.

- Firmware upgrade may take as long as 3 to 8 minutes over Internet, or just 1 minutes if it is performed on a LAN. It is recommended to conduct firmware upgrade in a controlled LAN environment if possible. For users who do not have a local firmware upgrade server.
- Htek's latest firmware is available at [www.htek.com](http://www.htek.com)→ Support→ Document & Firmware.
- Oversea users are strongly recommended to download the binary files and upgrade firmware locally in a controlled LAN environment.

#### To upgrade manually via the Web configuration interface

1. Click Management→ Upgrade

2. Click  or the blank.

3. Select the firmware (fw500M.rom) and then click .

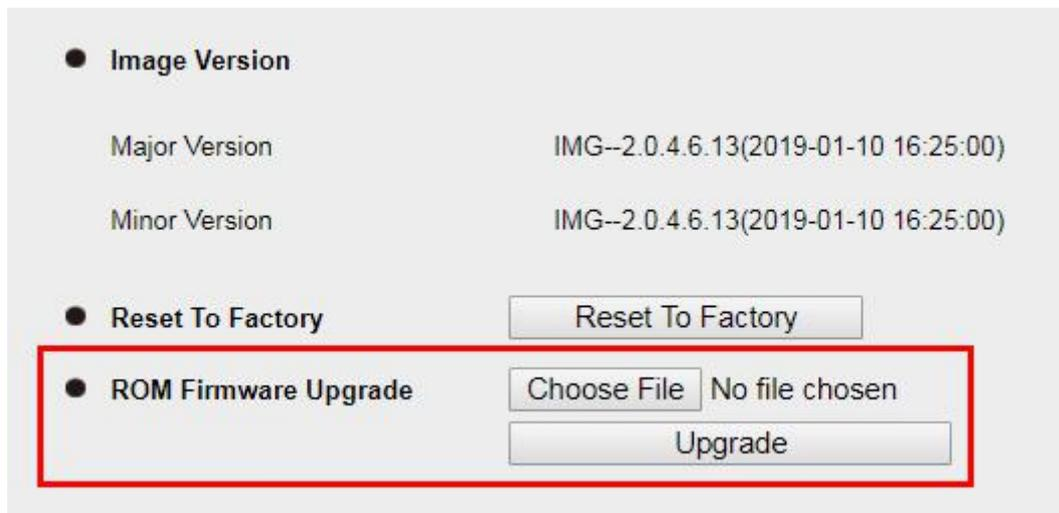

The screenshot shows a web configuration interface with the following sections:

- Image Version**
  - Major Version: IMG--2.0.4.6.13(2019-01-10 16:25:00)
  - Minor Version: IMG--2.0.4.6.13(2019-01-10 16:25:00)
- Reset To Factory**
- ROM Firmware Upgrade** (highlighted with a red box)
  - No file chosen
  -

## Configuration File

#### To download configuration file

1. Click Management→ Configuration→ Configure File

2. Click the  or , then you can get a file: cfg.xml or cfg.bin.

● **Configure File**

Download Device Xml Configuration	Download Xml File
Restore Xml Configuration	Choose File No file chosen
	Restore Xml Configuration
Download Device Bin Configuration	Download Bin File
Restore Bin Configuration	Choose File No file chosen
	Restore Bin Configuration
Download User Bin Configuration	Download User Bin File
Delete User Configuration	Delete User File

**To restore a configuration file**

1. Click Management→ Configuration→ Configure File

2. Select the xxx.xml or xxx.bin file, and then Click the

or , then IP Phone will reboot.

● **Configure File**

Download Device Xml Configuration	Download Xml File
Restore Xml Configuration	Choose File No file chosen
	Restore Xml Configuration
Download Device Bin Configuration	Download Bin File
Restore Bin Configuration	Choose File No file chosen
	Restore Bin Configuration
Download User Bin Configuration	Download User Bin File
Delete User Configuration	Delete User File

## Troubleshooting

### Why is the phone LCD screen blank?

- Ensure your phone is properly plugged into a functional AC outlet.
- Ensure that the phone isn't plugged into a plug controlled by a switch that is off.
- If the phone is plugged into a power strip, try plugging it directly into a wall outlet instead.
- If your phone is powered from PoE, ensure you use a PoE compliant switch or hub, or contact your system administrator for more information.
- Check if the power LED is on to ensure that the phone is powered on.

### Why does the phone display “Network Unavailable”?

#### To resolve:

- Ensure that the Ethernet cable is plugged into the Internet port on the phone and the Ethernet cable is not loose.
- Ensure that the switch or hub in your network is functioning well.
- If the problem still persists, Contact your system administrator for more information.

### Why can't I get a dial tone?

#### To resolve:

- Check for any loose connections and that the phone has been installed properly. For the Installation instructions, refer to the [Phone Installation](#) section.
- Check whether dial tone is present on one of the audio modes.
- Switch between the Handset, Headset (if you have) or Hands-Free Speakerphone to check whether dial tone is present for one of the audio modes.
- If the dial tone exists on another audio mode, connect a different handset or headset to isolate the problem.

### Where to set the tone?

You can set the tone on web interface:

- Click Setting→ Tones
- Define the Dial Tone, Ringback Tone, Busy Tone...
- For the tones, you can check with your system administrator.
- For More Click [Configure Ring Tones](#).

Select Country	Custom ▾
Dial Tone	f1=350@-13,f2=440@-13,c=0/0;
Ringback Tone	f1=440@-19,f2=480@-19,c=2000/4000;
Busy Tone	f1=480@-24,f2=620@-24,c=500/500;
Reorder Tone	f1=480@-24,f2=620@-24,c=250/250;
Confirmation Tone	f1=350@-11,f2=440@-11,c=100/100-100/100-100/100;
Call Waiting Tone	f1=440@-13,c=300/10000-300/10000-0/0;

**Syntax:** f1=freq@vol, f2=freq@vol, c=on1/off1-on2/off2-on3/off3; [...]

**Note:** freq: 0 - 4000Hz; vol: -30 - 0dBm

## How to download XML Configuration?

- Click Management → Configuration →

## How to Import Trusted CA certificate?

- Click Management → Trusted CA

Index	Issued TO	Issued By	Expiration	Delete
1				<input type="checkbox"/>
2				<input type="checkbox"/>
3				<input type="checkbox"/>
4				<input type="checkbox"/>
5				<input type="checkbox"/>
6				<input type="checkbox"/>
7				<input type="checkbox"/>
8				<input type="checkbox"/>
9				<input type="checkbox"/>
10				<input type="checkbox"/>

Import Trusted Certificate Files  No file chosen

Only Accept Trusted Certificates  On  Off

Common Name Validation  On  Off

Trusted Certificates  Default Certificates  
 Custom Certificates  
 All Certificates

## How to Import Server CA certificate?

- Click Management → Server CA

Issued TO	Issued By	Expiration	Delete
			Delete
Import Server Certificate Files	Choose File	No file chosen	
	Import Server Certificates		
Device Certificates	<input checked="" type="radio"/> Default Certificates <input type="radio"/> Custom Certificates		
	SaveSet	Cancel	

## How to use Vlan?

- For Vlan information, please click [VLAN](#)

## How to use LLDP?

- For LLDP information, please click [VLAN](#)
- VLAN Notes including:
  1. Voice VLAN
  2. Major Benefits of Using VLANs
  3. VLAN discovery method on Htek IP Phones
  4. LLDP Feature on Htek IP Phones
  5. Supported TLVS of IP Phones
  6. Configuring LLDP Feature
  7. DHCP VLAN
  8. Open the DHCP VLAN on the Htek IP Phones
  9. VLAN under Bridge Mode
  10. VLAN under NAT Mode

## How to Set LCD and Web GUI?

- Click [UC900 Series IP Phones Provisioning](#).

## How to Upgrade via FTP?

- Click [Upgrading Firmware of IP Phones](#).

## How to make Ringtone?

- Click [Make Ring Tones](#).

## How to use Open VPN?

- Click [Open VPN Guide](#).

## Provisioning Guide on Free PBX

- Click [FreePBX Configuring Guide](#).

## Redundancy Server

- Click [Redundancy Server](#).

## How to Use Auto Provision Phonebook?

- Click [AP Phonebook](#).

## All Documents

- Click [Documents Guide](#), you can get all tech files.